

# TAYNUILT GRID SUPPLY POINT: STRATEGIC DEVELOPMENT PLAN

Our network serving communities around  
Oban and the Mull/Coll/Tiree Archipelago

Draft for Consultation  
November 2024





# CONTENTS

<b>1. Introduction</b>	<b>8</b>
<b>2. Stakeholder Engagement and Whole System Considerations</b>	<b>10</b>
2.1. Local Authorities and Local Area Energy Planning	10
2.1.1. Argyll & Bute Council	10
2.2. Whole System Considerations	11
2.2.1. Network resilience for island groups connected by subsea cables	11
2.2.2. Diesel Embedded Generation (DEG) Decarbonisation	13
2.2.3. Transmission Interactions	13
2.3. Flexibility Considerations	13
<b>3. Existing Network Infrastructure</b>	<b>15</b>
3.1. Taynuilt Grid Supply Point Context	15
3.2. Current EHV Network Topology	16
3.3. Current Network Schematic	17
<b>4. Future electricity forecasts at Taynuilt GSP</b>	<b>18</b>
4.1. Distributed Energy Resource	18
4.1.1. DFES Projections	18
4.2. Transport Electrification	19
4.2.1. DFES Projections	20
4.3. Electrification of heat	21
4.3.1. DFES Projections	21
4.4. New building developments	22
4.4.1. DFES Projections	22
4.5. Commercial and industrial electrification	22
4.5.1. Distilleries	23
4.5.2. Maritime Industries within the Inner Hebrides	23
4.6. Generation and Demand Forecast Summary	23
4.6.1. Forecast Generation Capacity for Taynuilt GSP	23
<b>5. Works in progress</b>	<b>25</b>
5.1. Ongoing works at Taynuilt GSP	25
<b>6. Future system needs</b>	<b>28</b>
6.1. EHV Spatial Plans for Demand Future Needs	28
6.2. Extra High Voltage Specific System Generation Needs	31
6.3. Extra High Voltage Specific System Demand Needs	31
6.4. HV/LV spatial plans	32
<b>7. Options to resolve</b>	<b>36</b>
7.1. Overall dependencies, risks, and mitigations	36



7.2.	2050 High Level Options for EHV network .....	37
7.2.1.	EHV Options to 2035 affecting relevant Inner Hebridean islands .....	37
7.2.2.	EHV Options to 2035 affecting the mainland network .....	42
7.2.2.1.	Tullich Switching Station .....	42
7.2.2.2.	Oban Primary .....	43
7.3.	Future requirements of the High Voltage and Low Voltage Networks .....	43
7.3.1.	High Voltage Networks .....	44
7.3.2.	Low Voltage Networks .....	45
<b>8.</b>	<b>Recommendations .....</b>	<b>47</b>
	<b>Appendix A – Glossary .....</b>	<b>48</b>
	<b>APPENDIX B – GENERATION CAPACITY FORECASTS .....</b>	<b>50</b>
	<b>APPENDIX C – DEMAND FORECASTS .....</b>	<b>52</b>



# Executive Summary

SSEN is taking a strategic approach in the development of its distribution networks. This will enable net zero at a local level to the homes, businesses, and communities we serve.

Our strategic development plans take the feedback we have received from stakeholders on their future energy needs through to 2050 and translate these requirements into strategic spatial plans of the future distribution network needs of the future. Strategic spatial plans help us transparently present our future conceptual plans and facilitate discussion with Local Authorities and other stakeholders on how these could be translated in the local power systems of the future. To that end these are living plans reviewed as and when stakeholders tell us of changes to their future requirements.

These plans become blueprints for our future plans, shaped by stakeholder feedback. On an annual basis, or as parties seek to connect or change their power use, we will use the strategic development plans to guide our more detailed development works through the Distribution Network Options Assessment (DNOA)<sup>1</sup> process. Through the DNOA process, we typically look at detailed development of options for additional capacity up to seven years ahead of need. This approach ensures that our projects and flexibility opportunities are developed as part of an overall strategic design of our networks

To that end this, our strategic development plan carries several recommended interventions that we believe need to be progressed through the DNOA process. These will be further developed in 2024 and the detailed project proposals published in a forthcoming DNOA outcomes report. This report will also provide context on the timescale for delivery of infrastructure works or use of flexibility services.

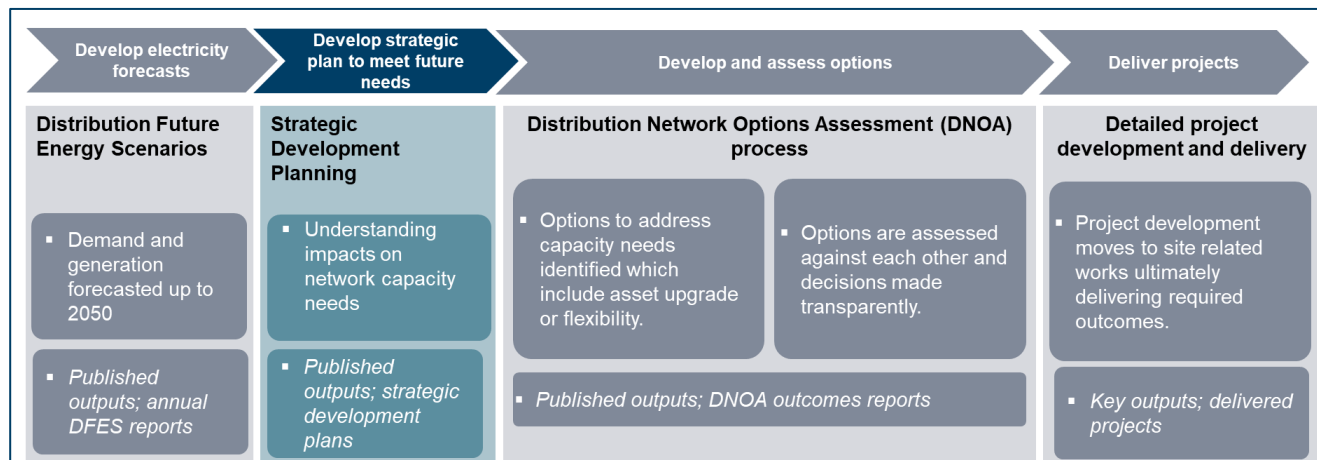


Figure 1 Overview of SSEN's Strategic Planning Process.

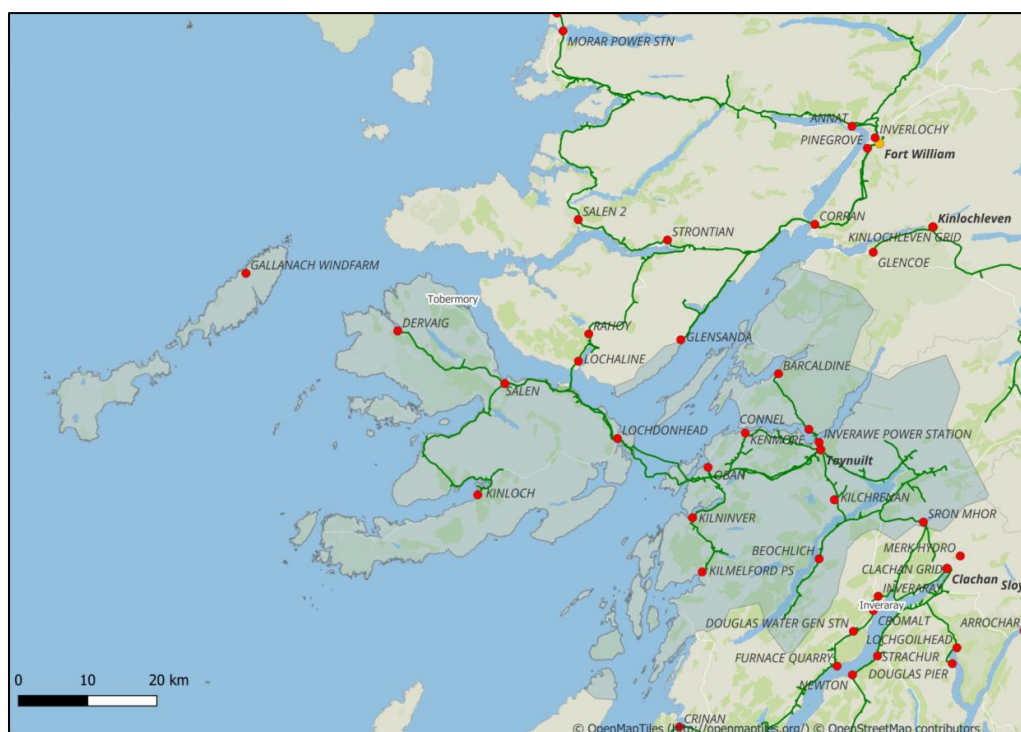
The overall strategic planning process is summarised above. We adopt a neutral facilitator role throughout our strategic planning process exploring flexibility options alongside network investment needs. Flexibility is a key component in the transition to Net Zero both assisting in earlier connection of customers as well as helping to optimise timing decisions around future investment needs.

<sup>1</sup> Earlier this year we published our first Distribution Network Options Assessment (DNOA) methodology describing how we are making transparent decisions over flexibility and network investment options. The DNOA methodology forms a key component of our Net Zero strategic planning process. <https://www.ssen.co.uk/globalassets/about-us/dso/consultation-library/distribution-network-options-assessment-dnoa--making-decisions-on-the-future-use-of-flexibility.pdf>



We operate our local networks across a range of differing voltage levels as power is transformed down to reach individual homes and businesses. Our Net Zero strategic plan considers networks at all these voltage levels and is tailored to the specific needs of each type recognising their different challenges.

This report focuses on the Taynuilt Grid Supply Point (GSP), which supports the greater network around Loch Awe, Oban, and the Mull Archipelago. A GSP is an interface point with the national transmission system where SSEN then takes power to local homes and businesses within a geographic area. The specific geographic area is shown in **Figure 2** below. It is predominantly rural and so relies on a combination of underground cables, overhead power lines and subsea cables to provide electrical supplies. This area covers the local authority of Argyll and Bute Council



**Figure 2 Geographic area covered by this report.**

This geographic area is within the scope of the 'Hebrides and Orkney Whole System Uncertainty Mechanism' (HOWSUM). This is a regulatory mechanism, forming part of our current price control period agreement with Ofgem, which provides SSEN with a route to apply for additional funding to deliver whole system solutions for net zero and to support the security of supply in the Scottish Islands

In the report, we provide an overview of critical aspects that will shape our future network development and planning. This includes an analysis of the evolving demand and generation requirements, as well as the impacts on our electricity networks:

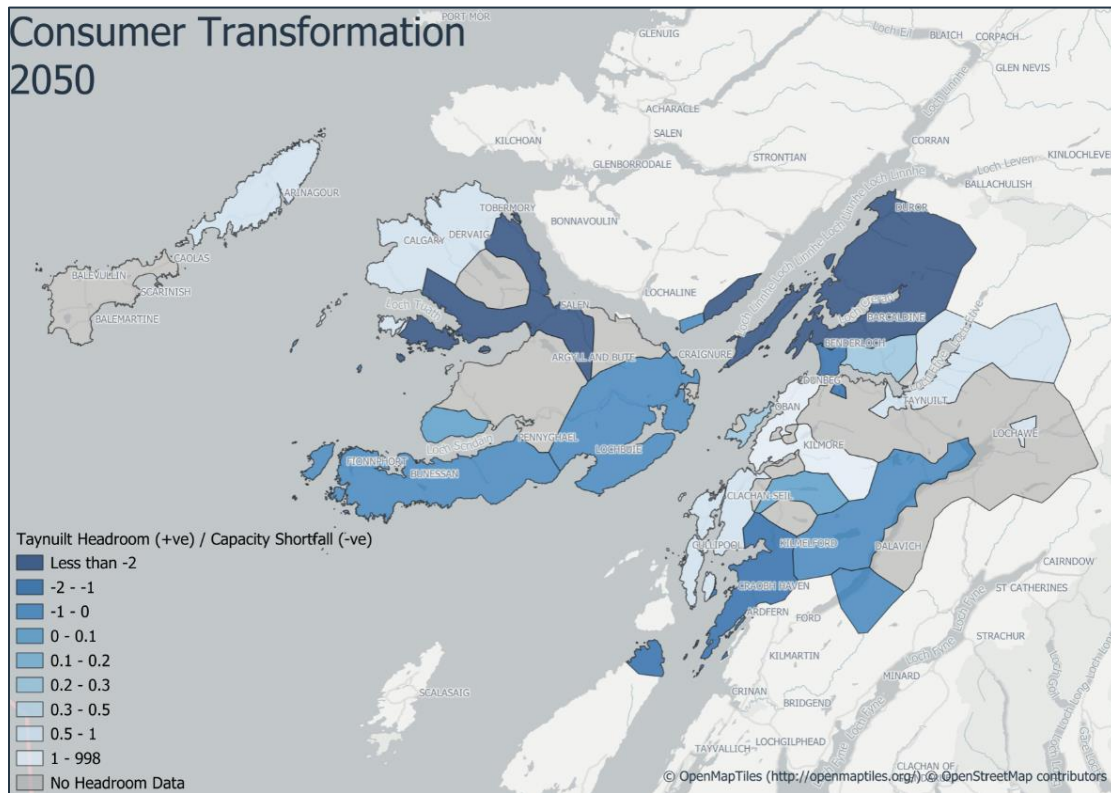
**The future demand and generation requirements for the wider Oban area, including the Mull Archipelago.** Much of this information is drawn from our work with Regen to develop the 2023 Distribution



Future Energy Scenarios (DFES). However, we also consider additional information from connection request activities in the area and local stakeholder insight.

**The impacts of these requirements on our electricity networks.** In the paper we describe how future requirements affect both our higher voltage networks and the lower voltage circuits feeding individual homes and businesses. From this we develop spatial plans of future network needs at key time intervals through to 2050.

The 2050 spatial plan for our Extra High Voltage (EHV) network is shown below in **Figure 3**. This shows us of potential areas of capacity need around Oban, and Salen and Dervaig primaries by 2050.



**Figure 3 Taynuilt 2050 EHV network spatial plan.**

The 2050 spatial plan for our High Voltage/Low Voltage (HV/LV) networks is shown in **Error! Reference source not found.** This plan shows the specific load driven requirements of different local communities and a need to take a bespoke approach to reinforcement of these networks and/or use of flexibility.

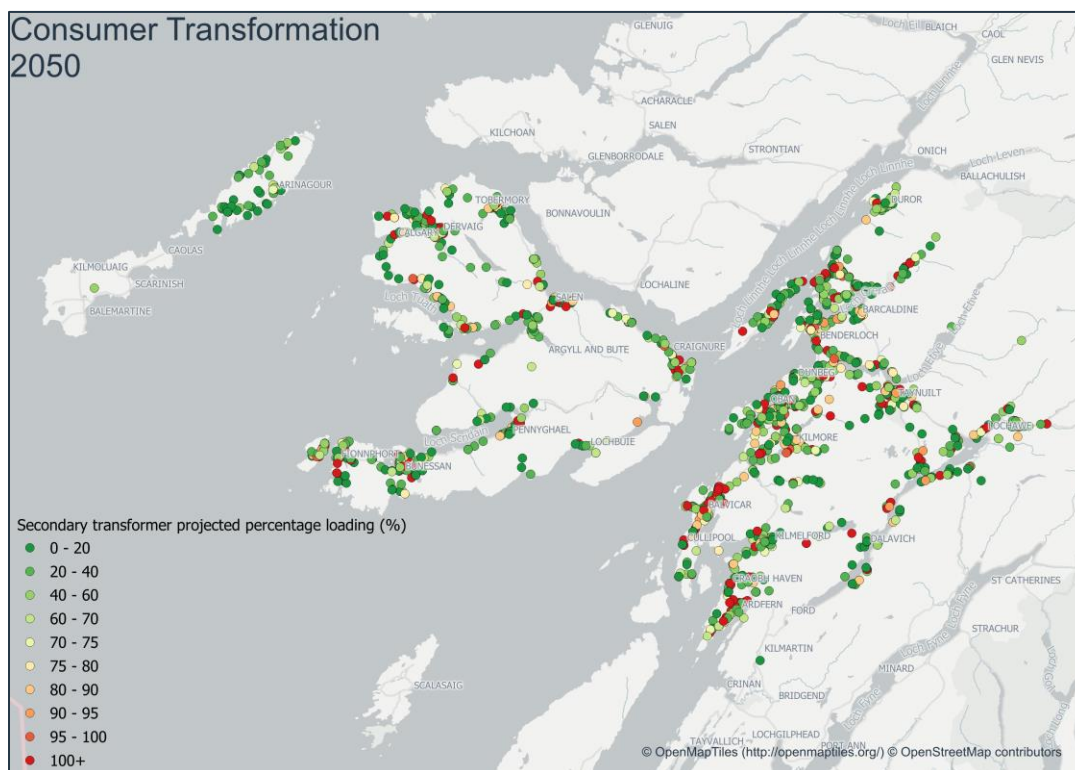


Figure 4 Taynuilt 2050 HV/LV network spatial plan.

**Proposed activities to resolve the system needs highlighted in the spatial plans.** In the report we provide an overview of work that we have already progressed through the DNOA process and initial proposals for projects that we recommend are developed further through the DNOA process. These are generally projects that we believe are needed within the next seven years. We also provide outline thoughts on longer term needs to 2050 with a view to further discussions with local stakeholders.

The pathways to decarbonisation and Net Zero are not always clear and our use of four DFES backgrounds in the report recognises these future uncertainties. Whilst the Taynuilt strategic development plan provides a best view of both our spatial needs and required activities; this is subject to change. This plan is therefore a living document that we will update annually reflecting changes from our updated DFES as well as insights gathered from local stakeholders.

This Strategic Development Plan is published as a draft report, and we welcome your feedback to shape both the form and content. We will use your feedback to inform both our final published Strategic Development Plan and future publications. Please submit any feedback to us through our inbox at: Whole.System.Distribution@sse.com

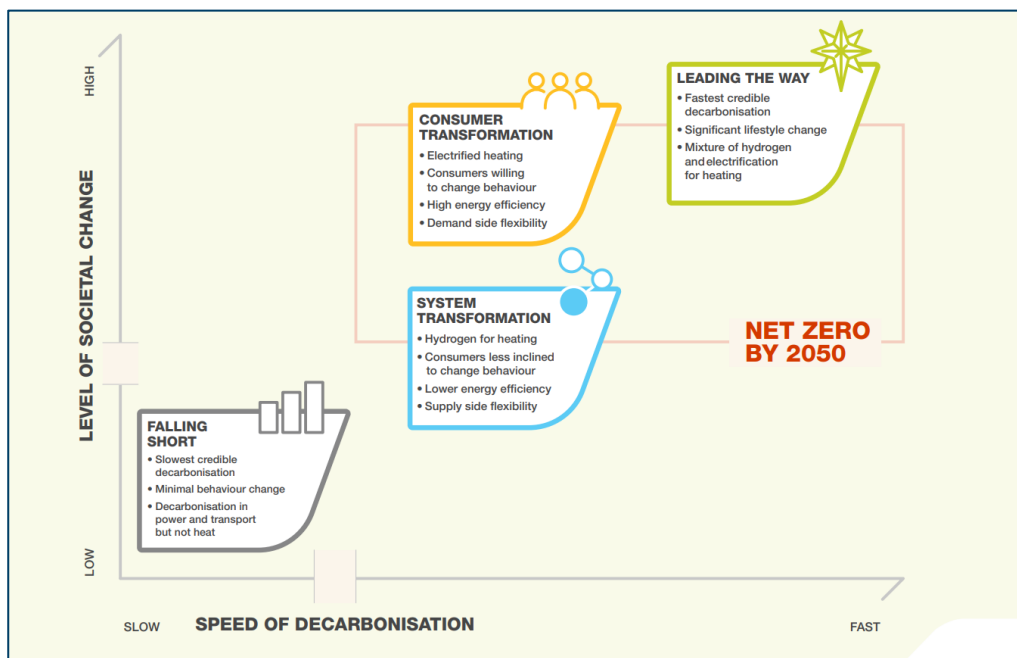


# 1. INTRODUCTION

The goal of this report is to demonstrate how local, regional, and national targets link with stakeholder views in the area to provide a robust evidence base for load growth out to 2050 across the Taynuilt Grid Supply Point (GSP) area. Further context for the area this represents is shown above in **Figure 2**.

To identify the future requirements of the electricity network, SSEN commissioned Regen to produce the annual Distribution Future Energy Scenarios (DFES). The DFES analysis is based off the National Grid Energy System Operator (ESO) Future Energy Scenarios (FES) while accounting for more granular stakeholder insights and new demand and generation connection applications. The DFES provides a forward-looking view of how demand and generation may evolve under four different scenarios as we move towards the national 2050 net zero target. These scenarios are summarized in **Error! Reference source not found.** SSEN use Consumer Transformation as the central case scenario following stakeholder feedback during the RIIO-ED2 development process. This position is reviewed annually.

Where new customer connection information has not been captured in the DFES, we aim to consider it as part of our studies to ensure that the projected load more accurately reflects what we expect to see in the future.



**Figure 5 The 4 Future Energy Scenarios adopted for the DFES. Source: ESO FES**

Using the DFES, power system analysis has been carried out to identify the future system needs of the electricity network. These needs are summarized by highlighting the year the need is identified under each of the four scenarios, and the projected 2050 load. Here, system needs are identified through power system analysis using the Consumer Transformation (CT) scenario (aligning with our RIIO-ED2 business plan), with sensitivity analysis carried out as part our high-level analysis on the other three scenarios to ensure we capture when these needs arise.

Once the preliminary system analysis is completed, and a list of reinforcement options to resolve the system needs is identified, our strategic plans are shared with stakeholders for review. After this, we begin the DNOA





process which will provide more detailed optioneering for each of these reinforcements, improving stakeholder visibility of the strategic planning process. Opportunities for procurement of flexibility will also be highlighted in the DNOA, to cultivate the flexibility markets, and to align with SSEN's flexibility first approach

Further details on our strategic development planning process can be found in our published methodology document<sup>2</sup>.

---

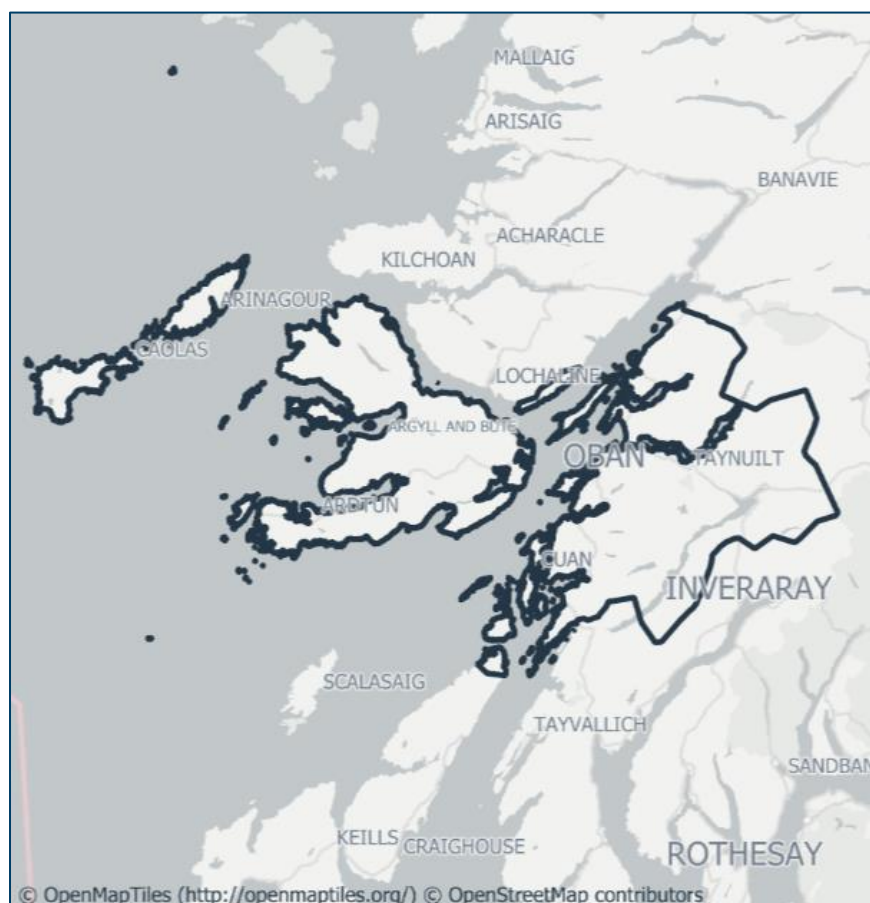
<sup>2</sup> [PowerPoint Presentation \(ssen.co.uk\)](https://www.ssen.co.uk)



## 2. STAKEHOLDER ENGAGEMENT AND WHOLE SYSTEM CONSIDERATIONS

### 2.1. Local Authorities and Local Area Energy Planning

The main local authority that is supplied by Taynuilt GSP is Argyll & Bute Council, as shown in **Figure 6**. The development plan for this local authority will have a significant impact on the potential future electricity load growth on SSEN's distribution network. As such, it is vital for SSEN to engage with these plans when carrying out strategic network investment.



**Figure 6 Taynuilt GSP Supply Area**

#### 2.1.1. Argyll & Bute Council

The 2022 Census enumerated the population of Argyll and Bute at 86,000. The National Records of Scotland (NRS) more recent mid-year estimates calculated Argyll and Bute's population to be 87,920 (NRS' 2022 based Mid-Year Estimates)<sup>3</sup>. Argyll and Bute council has the 27<sup>th</sup> highest population out of all 32 council areas in Scotland and covers the second-largest administrative area of any Scottish council, making up almost 9% of the country's land mass. It has the fourth sparsest population of the 32 Scottish local authorities, with an average population density of 13 persons per hectare. There are 23 inhabited islands in Argyll and Bute (Census 2011). These are: Bute, Coll, Colonsay, Danna, Easdale, Eilean da Mheinn, Erraid, Gigha, Gometra, Inchtavannach,

<sup>3</sup> [Argyll-bute.gov.uk](http://argyll-bute.gov.uk), May 2024, Population: Where We Live.



Innischonon, Iona, Islay, Jura, Kerrera, Lismore, Luing, Mull, Oronsay, Seil, Shuna, Tiree and Ulva. Argyll and Bute's inhabited islands, at the time of the 2011 Census, had a total population of 15,105. This equated to 17.1% of the total population for Argyll and Bute. The area has a diverse and vibrant economy, driven primarily by tourism, aquaculture, forestry, distilleries, and renewable energy.

Argyll and Bute Council has committed to become a [Net Zero organisation by 2045](#) in alignment with national targets. In their 2022-2025 [Decarbonisation Plan](#), the Council states that they endeavour to install more solar PV on council buildings, identify further opportunities for renewable energy sourcing, and produce an Electric Vehicle Infrastructure Strategy. The Council [is expanding](#) the electric vehicle charge point network via funding secured from Scottish Government. Through March 2026, residents in rural areas can take advantage of [ECO Grants](#) to install heat pumps and insulation in their homes.

## 2.2. Whole System Considerations

We have worked closely with local stakeholders, customers, market participants government bodies and transmission organisations to build on our engagement prior to RII0-ED2 and develop an enduring Whole System solution to meet the future energy needs of the areas supplied from Taynuilt GSP and to enable the region to support the transition to net zero through its extensive natural resource potential.

We are supported in this process by the Hebrides and Orkney Whole System Uncertainty Mechanism (HOWSUM). This regulatory mechanism facilitates exploration of the long-term strategies for decarbonisation and future resilience requirements for relevant island groups and the strategic development plans form a key stage in HOWSUM. We will be using high level options generated from this report and stakeholder feedback to produce detailed proposals that will be submitted to the Regulator in January 2025.

Through our whole system considerations, several options have been identified for future use in the local area, some based on specific feedback from island stakeholders. It should be noted that some of these elements are not sufficiently mature today, however, potentially form part of our longer-term strategic plans:

1. **Traditional Distribution elements:** We have considered how future network needs could be met with additional Distribution investment. It is generally recognised that all islands will need to remain connected to the mainland GB system so there is a definite need for continued Transmission and / or Distribution circuitry and capacity.
2. **Traditional Transmission elements:** We have worked closely with SSEN Transmission to understand their future requirements for the greater Argyll transmission and distribution networks.
3. **Use of new technologies:** We have discussed and will assess the use of new technologies such as hydrogen and other forms of storage to help resolve some of the drivers for change.
4. **Use of flexibility:** We see flexibility as potentially being required as part of all the developed options. For load related drivers, it can help optimise the timing of future investment needs.
5. **Repowering of diesel generators:** The potential to repower our diesel generators at Tiree with green alternatives is being considered as an option to help decarbonise the Scottish islands.

### 2.2.1. Network resilience for island groups connected by subsea cables

#### 2.2.1.1. Background

SSEN own and operate 446.5km of Distribution (33kV & 11kV) Submarine Cables, across 60 Islands within the Scottish Hydro Electric Power Distribution (SHEPD) license area covering the north of Scotland. As part of SHEPD's distribution Standard License Condition (SLC) 24 and the Distribution Code there is an obligation on



SSEN to ensure that certain levels of security are in place as per Engineering Recommendation P2 (ER P2). SLC 24 also requires SHEPD to demonstrate that the requirements of ER P2 are being met to provide demand centres with resilience in the event of network faults.

Subsea cable faults are rare events but can have a big impact on our island communities. Due to the nature of the environment in which they operate, fault location and repair on a subsea cable can take months. Therefore, there is an understanding within the SSEN business that some island communities served by our subsea cable assets require additional levels of resilience due to these prolonged outage times.

Given the uniqueness of the SSEN subsea network to the UK, Engineering Recommendation P2/8 does not account for the operational realities of faults on the subsea cable networks and as such, a different resilience standard is required. This enhanced resilience standard takes the form of SSEN’s newly developed Resilience policy for island groups connected by subsea cables which is explained further below.

Achieving these future resilience levels is the long-term ambition for our island groups and will be considered in any strategic planning of the island networks. Please note, this is not a replacement for the existing P2 planning requirements and is not to be retrospectively applied to our existing network.

We have assessed the level of resilience we currently provided to each of our island groups fed from sub-sea cables and developed this policy based on the demand group sizes stated within P2/8. **Table 1** below summarises the enhanced resilience standard developed for our Resiliency policy for Island Groups connected by subsea cables:

Group demand	Relevant 2050 P2-8 Category	Net Zero Resilience Policy for Island groups fed via subsea cables
Over 60MW and up to 300MW	D	Group demand secured for sustained long duration
Over 4MW And up to 60MW	C	N-2 condition through a combination of network assets and local generation (including third party).
Over 1MW And up to 4MW	B	Group demand secured for sustained long duration N-1 condition through a combination of network assets and local generation (including third party).
<1MW	A	N-2 condition managed through use of portable generation or use of existing generation on island if available.

**Table 1 – SSEN Group Demand sizes for Island Groups fed via subsea cables**



### 2.2.2. Diesel Embedded Generation (DEG) Decarbonisation

The Islands of Coll/ Tiree are currently supplied via a single 11kV subsea cable from Dervaig Primary on Mull. The islands are supported in fault scenarios by a 2.8MW diesel embedded generation station on Tiree.

SSEN has developed a 2050 strategy for the decarbonisation of its Diesel Embedded Generation (DEG) fleet. This will contribute to SSEN achieving its Science Based Targets (SBTs) outlined in the ED2 business Plan. Further details can be found in our Sustainability Strategy <sup>4</sup>.

This strategy will allow us to meet Scottish Government's forthcoming final position on NOx emissions from embedded plant. Specifically, this will mean our achieving 190mg/Nm<sup>3</sup> NOx emissions by 2033 (for planned system outages) and 2039 (for unplanned system outages).

The application of this strategy will be tailored to each island group, recognising both the needs of the island communities and the status of the existing DEG infrastructure. We will consider how DEG decarbonisation can be most efficiently enacted for that island group which could be through;

- Bringing forwards additional network resilience from our 2045 vision to reduce probability of operation (e.g. advancement of investment/reinforcement project delivery to provide additional network resilience);
- Use of flexibility solutions as an alternative to running DEG;
- Repowering DEG with alternative fuel sources such as Hydrotreated Vegetable Oil (HVO);
- Full review of the impact and management of our NOx emissions.

### 2.2.3. Transmission Interactions

Taynuilt GSP forms part of SSEN Transmissions Argyll and Kintyre 275kV Strategy. We have seen a significant increase in generator connection applications in Argyll and Kintyre, predominantly in renewable generation supporting the country's drive towards Net Zero. The SSEN Transmissions Argyll and Kintyre 275kV Strategy consists of three projects.

- Creag Dhubh to Dalmally 275kV Connection
- Creag Dhubh to Inveraray 275kV Connection
- Argyll and Kintyre 275kV Substations

The Creag Dhubh to Dalmally 275kV connection project includes the creation of a new 275kV substation at Creag Dhubh, facilitating the tie-in of the existing 132kV line (from Inveraray to Taynuilt GSP) to the wider 275kV transmission network. These works will enable renewable generation to connect to the GB transmission network and ensure the security of electricity supply to Taynuilt GSP.

## 2.3. Flexibility Considerations

Through its innovative Constraint Managed Zone (CMZ) initiative in 2016, SSEN was the first UK DNO to introduce Flexibility Services in their current commercial format. We are continuing to lead the way in this development resulting in over 700MW of Flexibility Services being procured in the 23/24 Financial Year.

---

<sup>4</sup> [SSEN Sustainability Strategy](#)



SSEN uses Flexibility Services to manage areas on our network that would otherwise have power flow that exceeded the network capacity. Flexibility Services are a key tool in the design and operation of the network and is used to support our network investment programme by enabling outages to go ahead, optimising the build programme and delaying reinforcement where economical to do so.

SSEN procures Flexibility Services from owners, operators, or aggregators of Distributed Energy Resources (DERs), which can be generators, storage, or demand assets. Services are typically needed at specific locations and times of day where high power flows are expected to occur.

In September 2024, we launched a Request for Information (RFI) to identify new Flexibility Service Participants in a selection of island communities and establish routes to market in this geographical location. The consultation closed on the 20th September and we are continuing conversations with participants as we develop our procurement strategy in these locations.

Historically we have managed demand in this area using Load Managed Areas (LMAs). These have relied on the use of radio teleswitches to optimise residential heating demand. Going forwards we will continue to value this use of flexibility to manage demand, and we are in the process of transitioning to a market-based solution.



## 3. EXISTING NETWORK INFRASTRUCTURE

### 3.1. Taynuilt Grid Supply Point Context

Taynuilt GSP supplies a rural network located in Argyll & Bute, where the land use is a mix of residential, commercial, industrial and agricultural. In total the GSP supplies approximately 14,548 customers with the breakdown for each substation shown in Table 2.

Substation Name	Site Type	Number of Customers Served	Transformer number / MVA rating	2024 Substation Maximum MW (Winter)
Barcaldine	Primary Substation	1,174	Single 7.5/15 MVA (CER) transformer	3.49
Kenmore	Primary Substation	96	Single 1.5 MVA transformer	0.17
Bonawe	Primary Substation	1	Single 0.5 MVA transformer	n/a
Dalmally	Primary Substation	87	Single 1 MVA transformer	0.15
Kilchrenan	Primary Substation	307	Single 1 MVA transformer	0.87
Eredine	Primary Substation	41	Single 0.2 MVA transformer	0.07
Taynuilt Primary	Primary Substation	520	Double 2.5 MVA transformer	1.00
Connel	Primary Substation	774	Single 8 MVA transformer	1.76
Oban	Primary Substation	6,366	Double 12/24 MVA (CER) transformers	15.16
Kilninver	Primary Substation	740	Single 2.5 MVA transformer	1.65
Scammadale	Primary Substation	33	Single 0.1 MVA transformer	0.06
Kilmelford	Primary Substation	601	Single 2.5 MVA transformer	2.32
Tiroran Bridge	Primary Substation	22	Single 0.2 MVA transformer	0.04
Kinloch	Primary Substation	671	Single 2.5 MVA transformer	1.52
Salen	Primary Substation	1,759	Double 6.3 MVA transformer	2.02
Dervaig	Primary Substation	1,017	Single 4/8 MVA (CER) transformers	3.28
Lochdonhead	Primary Substation	302	Single 1 MVA transformer	0.90
Kerrera	Primary Substation	37	Single 0.3 MVA transformer	0.06

**Table 2 Customer number breakdown and substation peak demand readings (2024)**



### 3.2. Current EHV Network Topology

Taynuilt GSP is supplied via two 90MVA 132/33kV grid transformers. The subsequent 33kV network is a combination of overhead line and underground circuits that operate as radial and ring networks, supplying customers in the greater Oban area of the western highlands.

The islands of Kerrera and Mull, are supplied from Taynuilt GSP via two 33kV circuits from Tullich Switching Station, near Oban. The 33kV circuits consist of overhead lines, underground cables and subsea cables. There is also a third 33kV supply to the islands that connects to the Fort William network, acting as a back-up supply in fault scenarios.

A 33kV ring operates on the isle of Mull which supports several Primary substations (Lochdonhead, Salen, Dervaig, & Kinloch). These in turn support the isles of Iona, Ulva, Coll and Tiree via the 11kV network.

SSEN Distribution also own and operate a 2.7MW Diesel Power Station on Tiree to support the Tiree and Coll in the event of a fault on the 11kV network.

The existing 33kV network topology is shown in **Figure 7** below.



**Figure 7 Taynuilt GSP Geographic Information System (GIS) View**







## 4. FUTURE ELECTRICITY FORECASTS AT TAYNUILT GSP

The following section details load growth across the technologies projected in the Distribution Future Energy Scenarios. Where megawatt (MW) values are presented in this section, they represent total installed capacity. When conducting network studies these values are appropriately diversified to represent the coincident maximum demand of the entire system rather than the total sum of all demands. The projections presented here are the outputs from the most recent DFES 2023 analysis

Individual DFES technology forecasts, along with connections data and insights from specific stakeholders are then assessed to develop profiled forecasts of demand and generation. These profiles can be found in section 5.6 of this report with further context in the appendix to this report.

### 4.1. Distributed Energy Resource

#### 4.1.1. DFES Projections

##### 4.1.1.1. Generation

Based on the DFES projections, distributed connected renewable generation across Taynuilt GSP group will increase significantly from 75MW in the currently connected baseline to between 98MW and 320MW in 2050 (dependent on scenario as shown in **Figure 9**). We see decommissioning of Gas and Diesel generation ahead of 2035, with onshore wind and marine accounting for much of the distributed generation from 2035 onwards and hydropower maintaining at current levels.

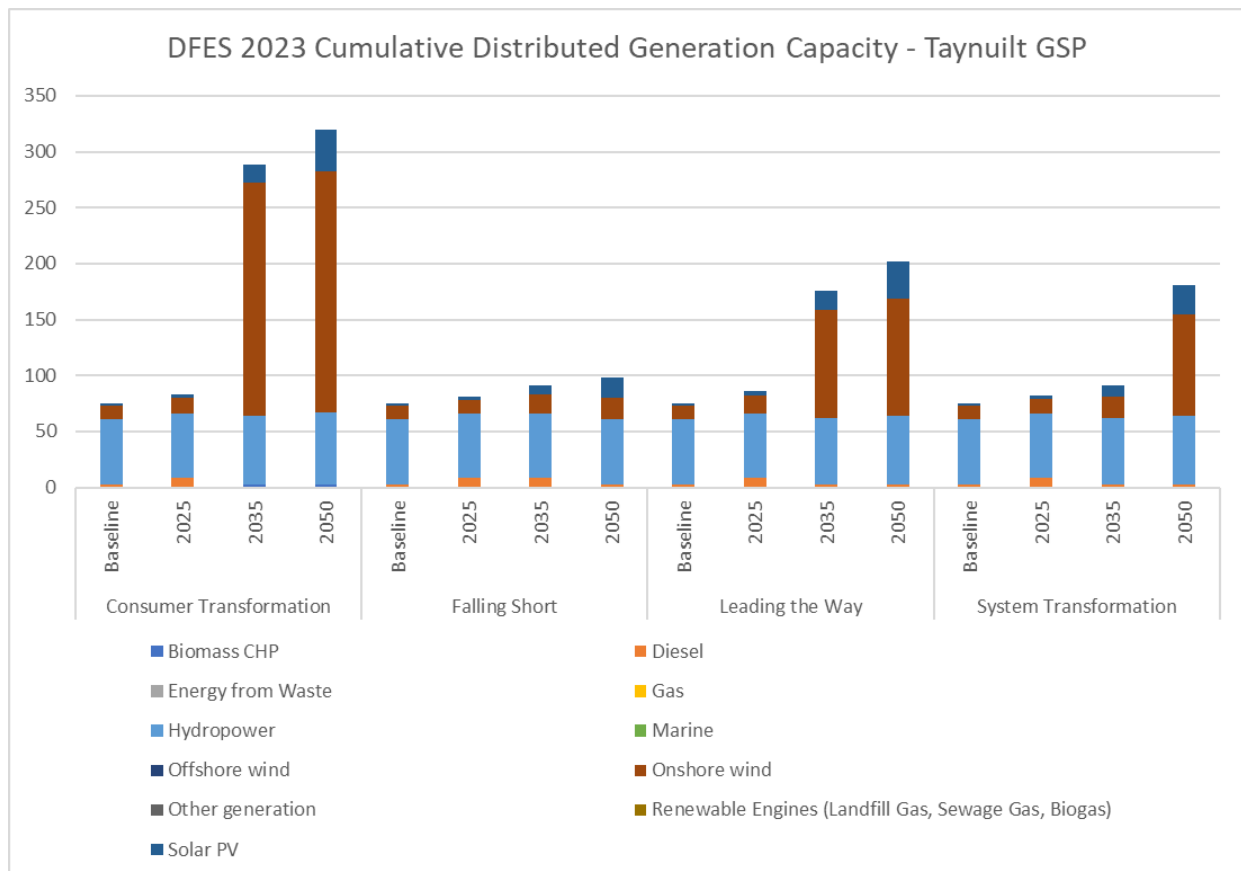
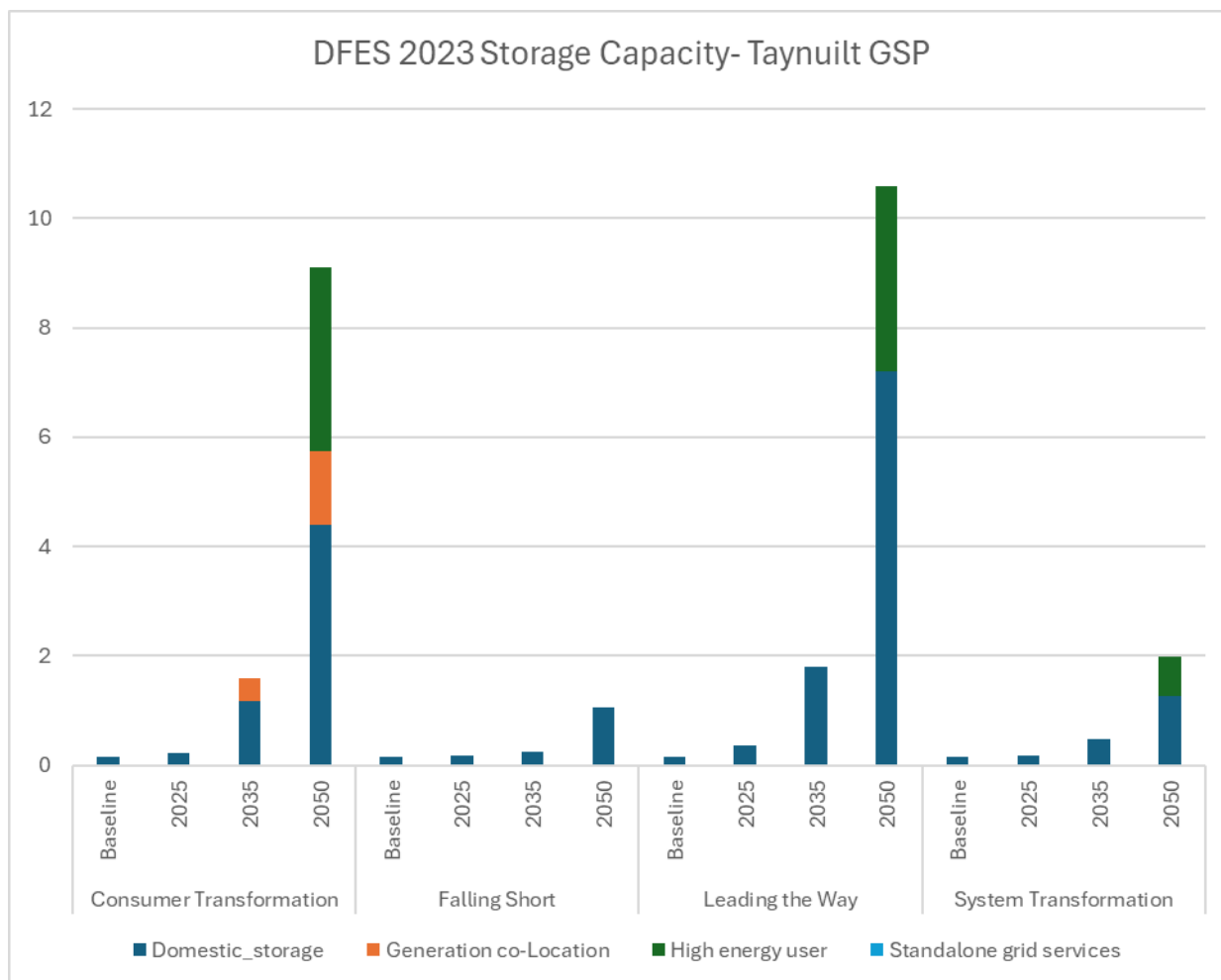


Figure 9 Projected Cumulative Distributed Generation Capacity Taynuilt GSP (MW). Source: SSEN DFES 2023



### 4.1.1.2. Storage

While multiple storage technologies have projected uptake modelled in the DFES, in the Taynuilt GSP supply area we only see a significant increase in the installation of domestic batteries (shown in **Figure 10**). This refers to those 1-15kW in scale, designed to enable households to increase the self-consumption of domestic solar PV, as well as acting as a backup power supply households in more rural locations. A cumulative storage capacity of between 9.1MW and 10.6MW is projected by 2050 under the Consumer Transformation and Leading the Way scenarios respectively.



**Figure 10 Projected Cumulative Storage Capacity Taynuilt GSP (MW). Source: SSEN DFES 2023**

## 4.2. Transport Electrification

Future electricity demand from transport could come from three different transport sectors that are on very different timelines. EV charging is likely to see rapid adoption to meet demand from residents and visitors. The development of shore power charging for ferries is already being explored with SSEN at key port locations; other vessels may increase future capacity requirements at these locations. Commitments from Loganair and Airtask, who operate flights at the three island airports are pushing for the electrification of on-ground assets, vehicles, and a longer-term view for aircraft decarbonisation.



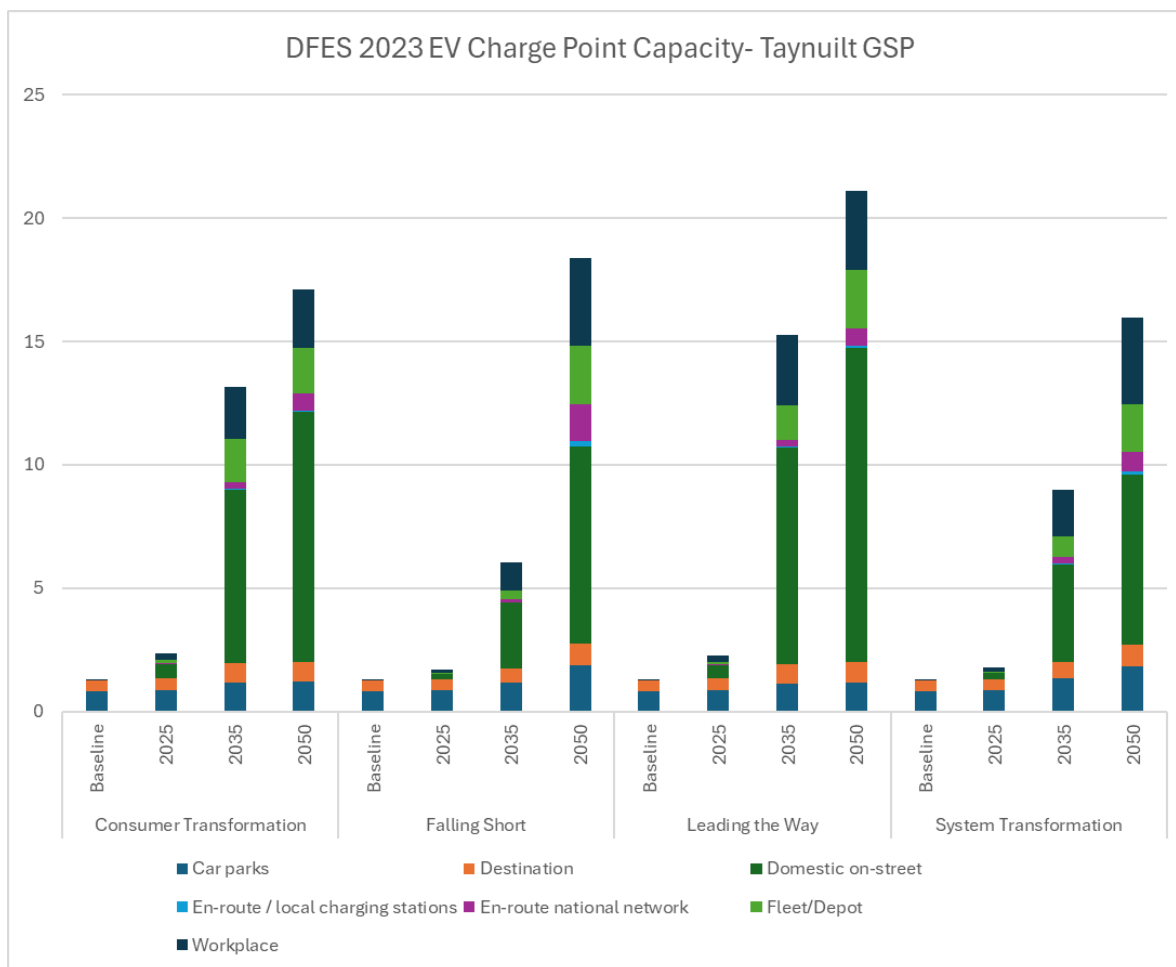
The impact of increasing levels of tourism on the area’s future transport load growth is a key consideration. Additional capacity requirements, particularly in the summer months, could significantly impact the distribution network.

### 4.2.1. DFES Projections

SSEN's 2023 DFES analysis, there could be just over 10,300 (2023 LW) EV cars and light goods vehicles (LGVs) registered in the Taynuilt GSP area (Greater Oban, Mull Archipelago) by 2035.

As the network operator, it is important for SSEN to understand the network facing demand of EVs. To do this we can use the projected EV charger capacity (MW) from SSEN's DFES analysis. The SSEN DFES project that the total connected EV charge point capacity under Taynuilt GSP, excluding off-street domestic chargers, could total 15.3MW (2023 LW) by 2035 (as shown in **Figure 11**). It is important to note that this value represents the total installed capacity and does not consider diversity. In our studies for future system needs diversity is taken into consideration so the studied capacity across Taynuilt GSP is not equivalent to 15.3MW.

The uptake of domestic off-street chargers follows a similar trend. By 2035, there could be 6,500 (2023 LW) domestic off-street chargers installed under Taynuilt GSP with this increasing to approximately 6,800 (2023 LW) by 2050.



**Figure 11 Projected EV Charge Point Capacity across Taynuilt GSP group. Source: SSEN DFES 2023**

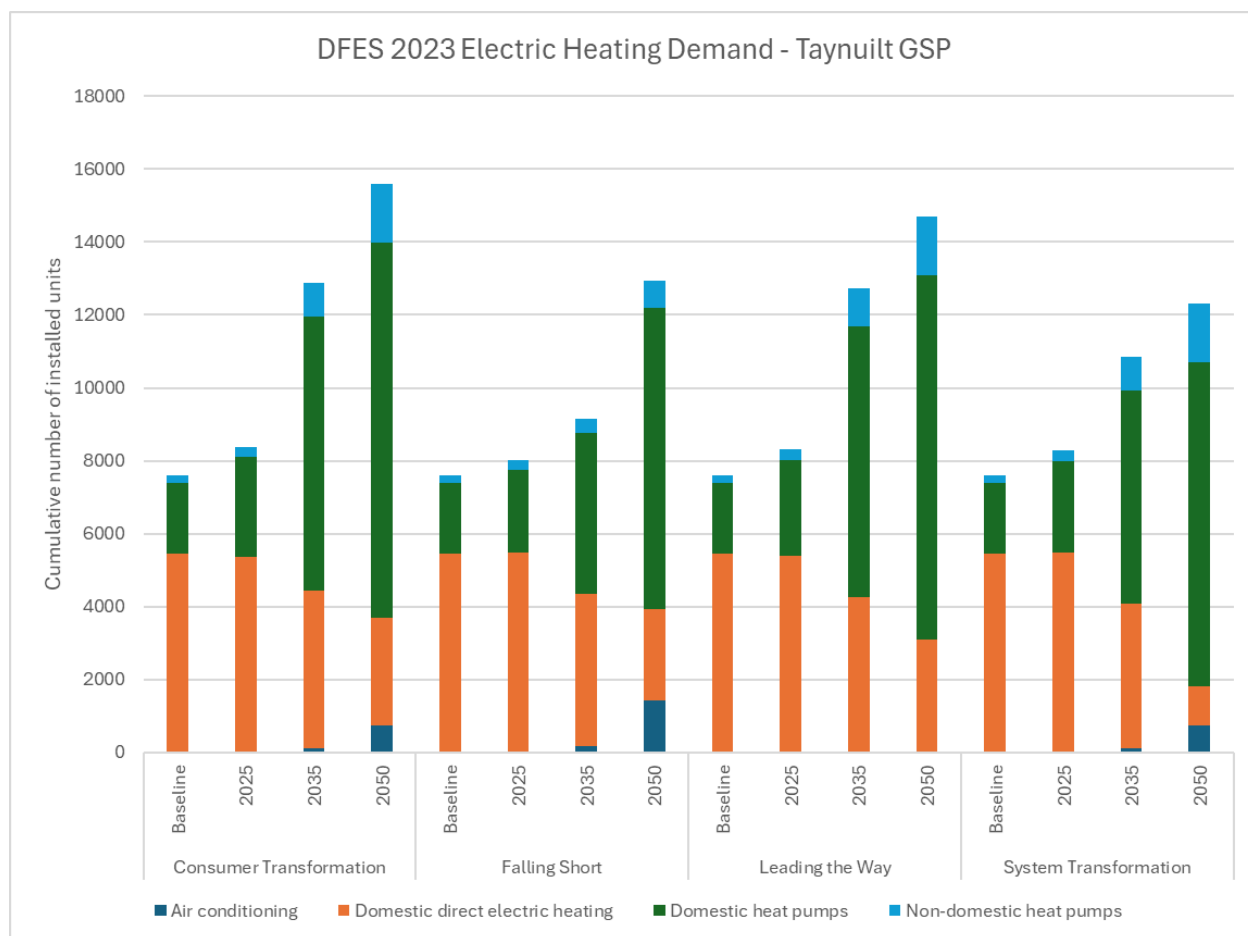


### 4.3. Electrification of heat

The decarbonisation of space heating technologies in homes and businesses will have a significant impact on the future energy system. Historically in Argyll & Bute, central heating is mainly attributable to mains gas (44%) and to electric heating (27% Including storage heaters)<sup>5</sup>. Government legislation and consumer behaviour are just two of many factors that will impact the future electricity demand arising from space heating.

#### 4.3.1. DFES Projections

Under all scenarios, we see an increase from a baseline of 1,921 domestic heat pumps to between 8,261 & 10,273 by 2050 connected to the network under Taynuilt GSP (as shown in **Figure 12**). Decarbonising space heating technologies in homes and businesses could be a significant consideration for future electricity load in the Inner Hebrides. The islands currently has no mains gas connection and so households rely on direct electric heaters (radiant and night storage), oil and solid fuels for heating. In addition, the Inner Hebrides’ relatively older housing stock results in households using more fuel for space heating over the year than some other parts of GB.



**Figure 12 Projected number of Heat Pumps across Taynuilt GSP group. Source: SSEN DFES 2023**

<sup>5</sup> Census 2011, June 2024, Central Heating.



## 4.4. New building developments

To produce the SSEN DFES, Regen undertook engagement with local authorities to understand local authority development plans across our licence areas.

### 4.4.1. DFES Projections

For Taynuilt GSP supply area approximately 450 new homes are projected by 2050 under all scenarios.

In addition to domestic development, the DFES also projects the cumulative floorspace of non-domestic new developments. **Figure 13** shows that the two building classifications contributing to the largest floorspace growth are factory and warehouse developments, and new office space.

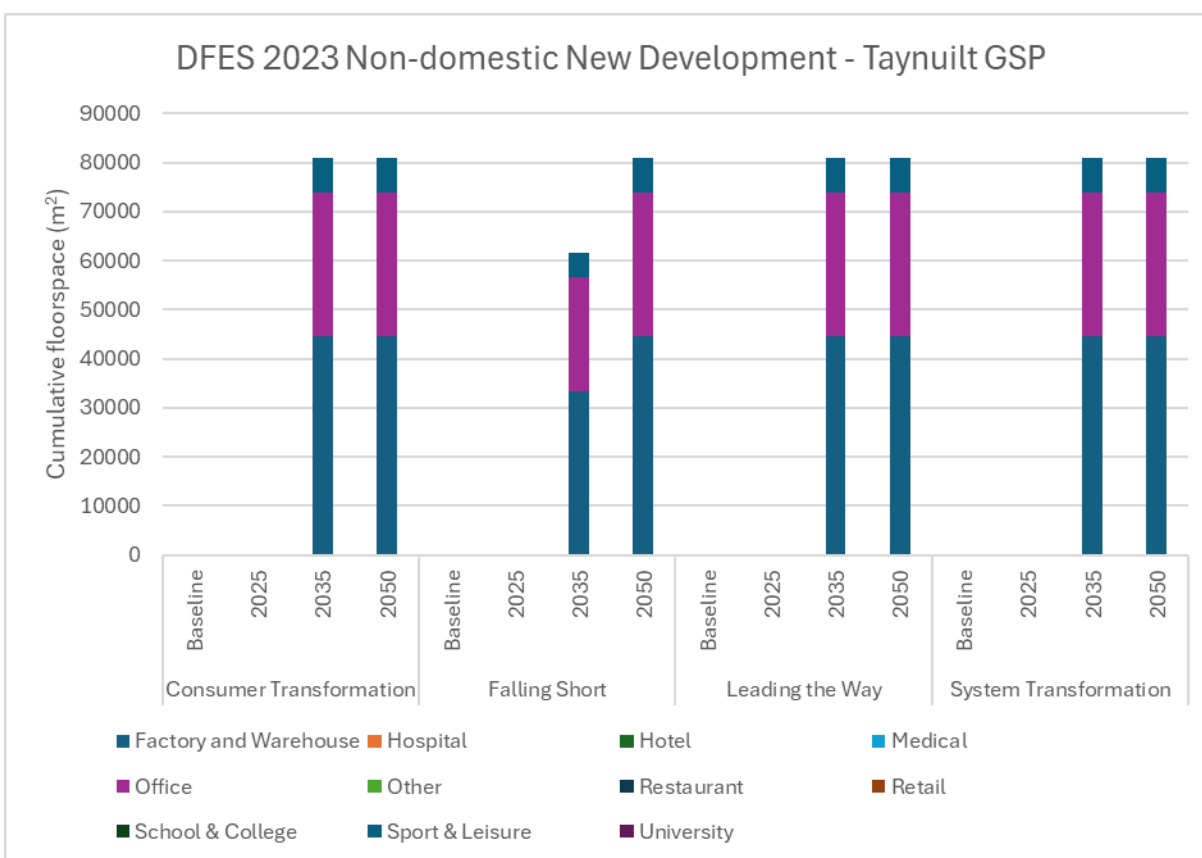


Figure 13 Projected new non-domestic development across Taynuilt GSP. Source: SSEN DFES 2023

## 4.5. Commercial and industrial electrification

We recently commissioned Regen to explore more deeply the decarbonisation of demand on Scottish Islands. The detailed analysis conducted by Regen regarding the decarbonisation of industries specific to Northern Scotland (i.e. whisky distilleries, fish and seaweed farming) and broader industries (e.g. agriculture and other commercial businesses) indicate there could be a range of potential electrification outcomes affecting Taynuilt GSP. We have identified distilleries and the port industry as areas of significant future demand growth for the Taynuilt. Below we summarise these findings and the impacts on our analysis work.



### 4.5.1. Distilleries

The Inner Hebrides currently hosts nearly two dozen operational distilleries that produce spirits including whisky, gin and rum. Three of those are located on the Mull Archipelago. The distillation process is energy intensive, fuelled by fossil fuels and accounts for a significant proportion of energy demand across respective islands.

The wider whisky industry has made progress towards decarbonisation, with non-fossil fuels making up 20% of its energy use in 2018, up from only 3% in 2008<sup>6</sup>. Regen engagement with the Scotch Whisky Association (SWA) highlighted that their 2023-25 strategy includes commitments to achieving net zero emissions in their own operations by 2040<sup>7</sup>. A Ricardo report commissioned by the SWA in 2019 investigated how carbon reduction in the distillery industry could be achieved<sup>8</sup>. The Regen analysis provided qualitative information on the distilleries. However, we are in the process of developing a methodology to forecast the electrical demand for distilleries which will form part of the system needs in future analysis.

### 4.5.2. Maritime Industries within the Inner Hebrides

The timeframe of possible electricity load growth is heavily linked to the timeline of individual vessel propulsion systems being changed/replaced. This timeline is currently difficult to quantify due to uncertainties around technology readiness. However, partial/hybrid or full electrification at some scale (as opposed to ammonia or biomethane) is being considered, particularly for smaller-scale roll-on/roll-off ferries.

Ferries are one of the primary modes of maritime transport across the Inner Hebrides. As such, the associated use of shore power to charge these vessels could equate to a significant load at each of the relevant ferry terminals. In addition to their shore power requirements, the ferries charging profiles and ports' abilities to charge EVs will be major considerations for any network reinforcement.

## 4.6. Generation and Demand Forecast Summary

The data presented in sections 5.1-5.5 of this report is utilised in the development of profiled forecasts of demand and generation on our networks. These are shown in further detail in Appendices A and B whilst in this section we summarise the information presented.

### 4.6.1. Forecast Generation Capacity for Taynuilt GSP

Appendix A shows the forecast generation capacity relate to the cumulative capacity (MW) of distribution connected generation projects across both Port Ann and Carradale GSPs. The charts are broken down into technology types expected to connect across the network and do not relate to coincident peaks for each technology.

**Table 3** below summarises the cumulative forecast generation capacity from today to 2050 for Taynuilt GSP.

---

6 Heriot Watt University, 2021. [Distilleries need blend of green energy and storage for net zero.](#)

7 Scotch Whisky Association, 2021. [The Scotch Whisky Industry Sustainability Strategy.](#)

8 Scotch Whisky Association (Ricardo), 2020. [Scotch whisky pathway to net zero.](#)



Substation	CT Scenario (in MW)				LW Scenario (in MW)			
	2024	2028	2040	2050	2024	2028	2040	2050
Taynuilt GSP	76.84	265.71	299.29	320.02	77.49	93.57	185.91	201.90
Substation	ST Scenario (in MW)				FS Scenario (in MW)			
	2024	2028	2040	2050	2024	2028	2040	2050
Taynuilt GSP	75.96	84.56	164.38	181.13	75.88	82.76	90.78	98.37

Table 3 Forecast Generation Capacity for CT, LW, ST and FS scenarios in Taynuilt GSP

### Demand Forecast for Taynuilt GSP

Appendix B shows forecast demands for each DFES scenario through to 2050. These forecasts are taken as winter peak demand at each primary with any effect of embedded generation netted off. Information relating to industrial decarbonisation impacts will be added to these values in any detailed analysis undertaken.

This information is summarised for the demand at Taynuilt, within the Mull Archipelago in **Error! Reference source not found.** below.

Substation	CT Scenario (in MW)				LW Scenario (in MW)			
	2024	2028	2040	2050	2024	2028	2040	2050
Taynuilt GSP	34.56	41.50	61.34	67.76	34.52	45.11	71.60	86.97
Substation	ST Scenario (in MW)				FS Scenario (in MW)			
	2024	2028	2040	2050	2024	2028	2040	2050
Taynuilt GSP	34.50	39.03	58.55	72.72	34.36	36.40	50.27	57.69

Table 4 Forecast Demand for CT, LW, ST and FS scenarios in Taynuilt GSP





## 5. WORKS IN PROGRESS

### 5.1. Ongoing works at Taynuilt GSP

Network interventions can be caused by a variety of different drivers. Examples of common drivers are load-related growth, specific customer connections, and asset health. Across Taynuilt GSP these drivers have already triggered network interventions that have now progressed to detailed design and delivery. For this report, these works are assumed to be complete, with any resulting increase in capacity considered to be released.

For this report, there are some capital works are undergoing to meet the demand requirements in Taynuilt. These are summarised in **Table 3 below**:

Substation	Description	Driver	Forecast completion	Provides sufficient capacity for 2050 Peak Demands (Consumer Transformation)
Kilniver	New 33kV circuit, New primary substation	DNOA process	2033	
Kinloch	New primary substation	DNOA process	2028	
Dervaig	11kV Subsea Cable Replacement (Coll – Tìree)	DNOA process	2026	
Kinloch	11kV Subsea Cable Replacement (Mull – Iona)	DNOA process	2026	
Dervaig	3 x 2MVAr STATCOM Installation	DNOA process	2033	

**Table 3 Works already triggered through customer connections and the DNOA process.**

Where the above works are marked as not providing sufficient capacity for 2050 peak demands, it is important to note that this relates to the individual primary substation's firm capacity. When considering the further works identified in this report, the holistic plans provide capacity across the GSP for 2050.

Alongside these asset solutions being deployed, flexibility solutions are also being used to release additional capacity.



## 5.2. Network Schematic (following completion of above works)

The network considered for long-term modelling is shown in **Figure 14**, **Figure 15** and **Figure 16**.

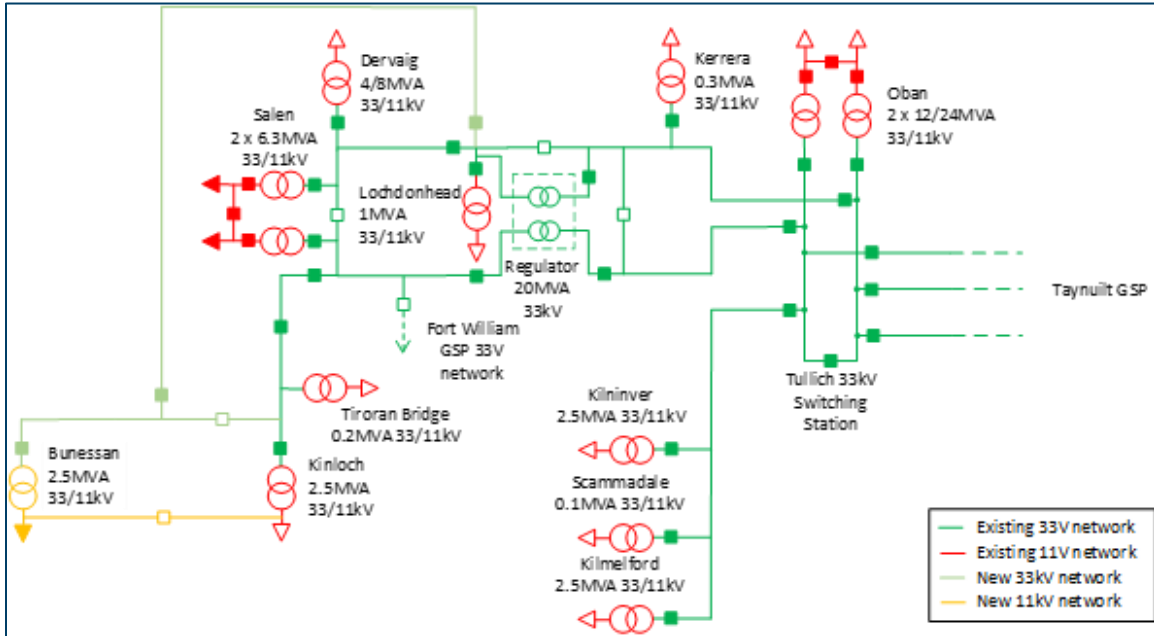


Figure 14 Taynuilt GSP network schematic – Mull Archipelago following completion of triggered works.

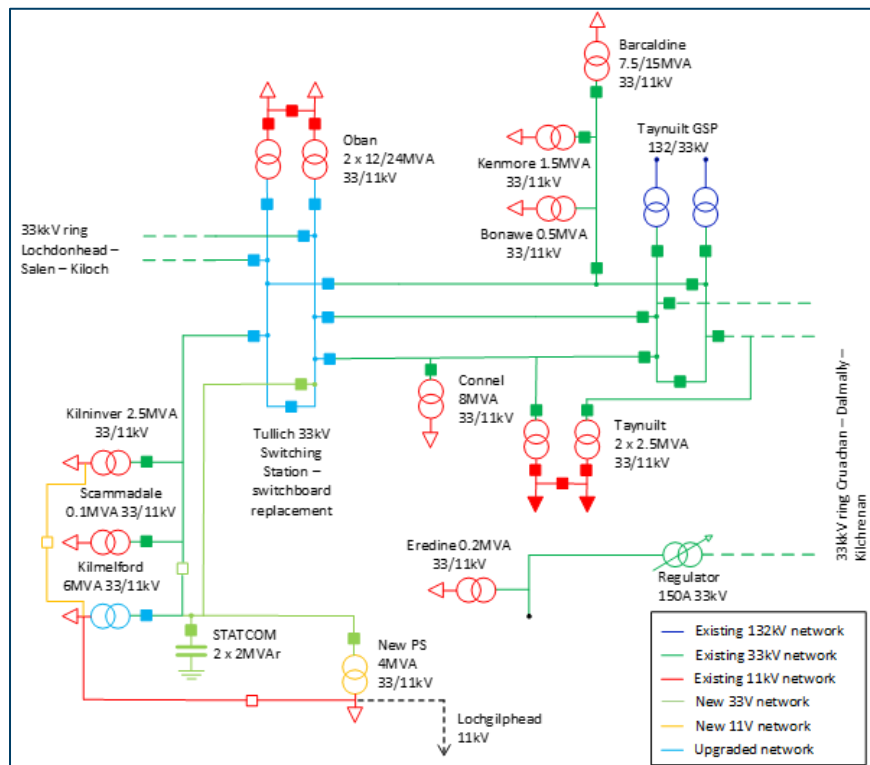


Figure 15 Taynuilt GSP network schematic – Kilninver / Kilmelford following completion of triggered works.

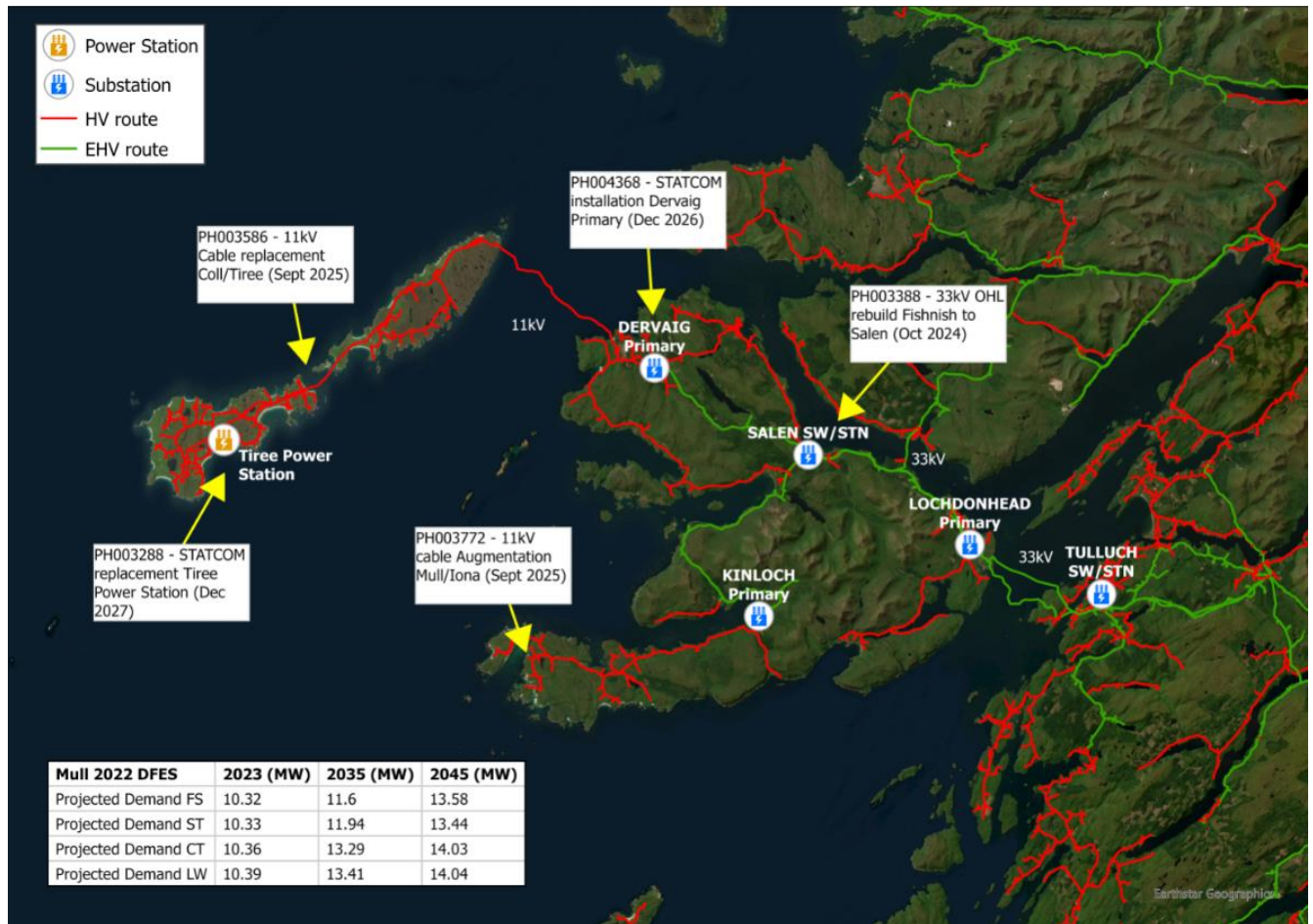


Figure 16 GIS view of network with works in progress and system needs annotated.



## 6. FUTURE SYSTEM NEEDS

In the previous sections we discussed the Regen DFES Demand and Generation forecasts for Taynuilt. We have used this information to understand what this means for the local networks in Argyll & Bute. Initially this is developed through the creation of a spatial plan of future system demand needs looking at periods of maximum demand with minimum generation. These will be augmented in the future to include spatial plans of low demands with high generation output.

We have created spatial plans at a primary substation level (66/11kV or 22/11kV) and secondary substation level (11kV/LV). Snapshots are provided for 2028, 2033, 2040, and 2050 enabling clear visualisation of future distribution system needs beyond the network capacity following completion of triggered works. They are currently based on 2023 DFES.

These spatial plans consider the distribution network requirements to capacity requirements. They do not account for the enhanced network resilience policy for island groups fed by sub-sea cables, nor do they account for any needs arising from the transmission system.

### 6.1. EHV Spatial Plans for Demand Future Needs

The EHV spatial plans for the four DFES 2023 scenarios are highlighted in **Figure 17**, **Figure 18**, **Figure 19** & **Figure 20** for CT, LW, FS and ST respectively.

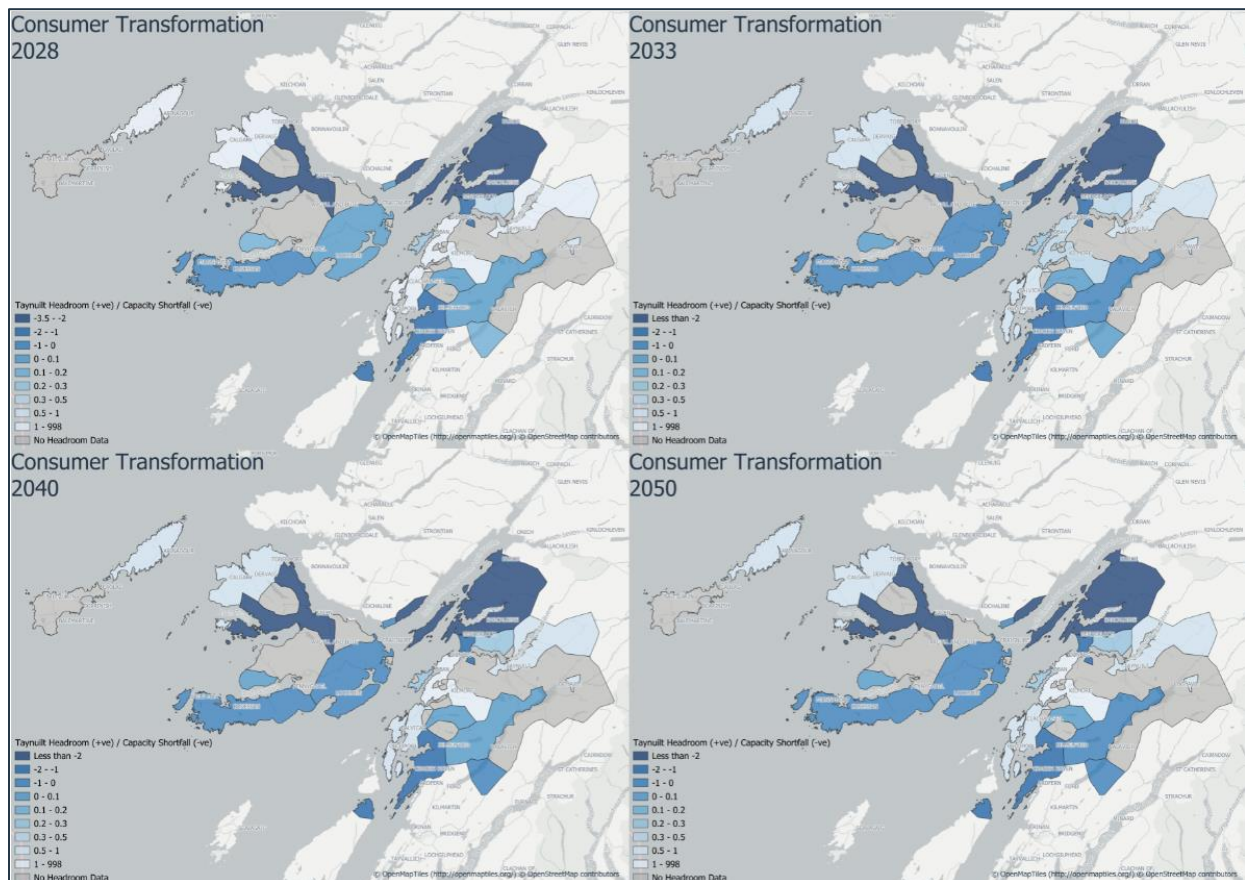


Figure 17 Taynuilt GSP EHV spatial plans for CT 2028, 2033, 2040, and 2050

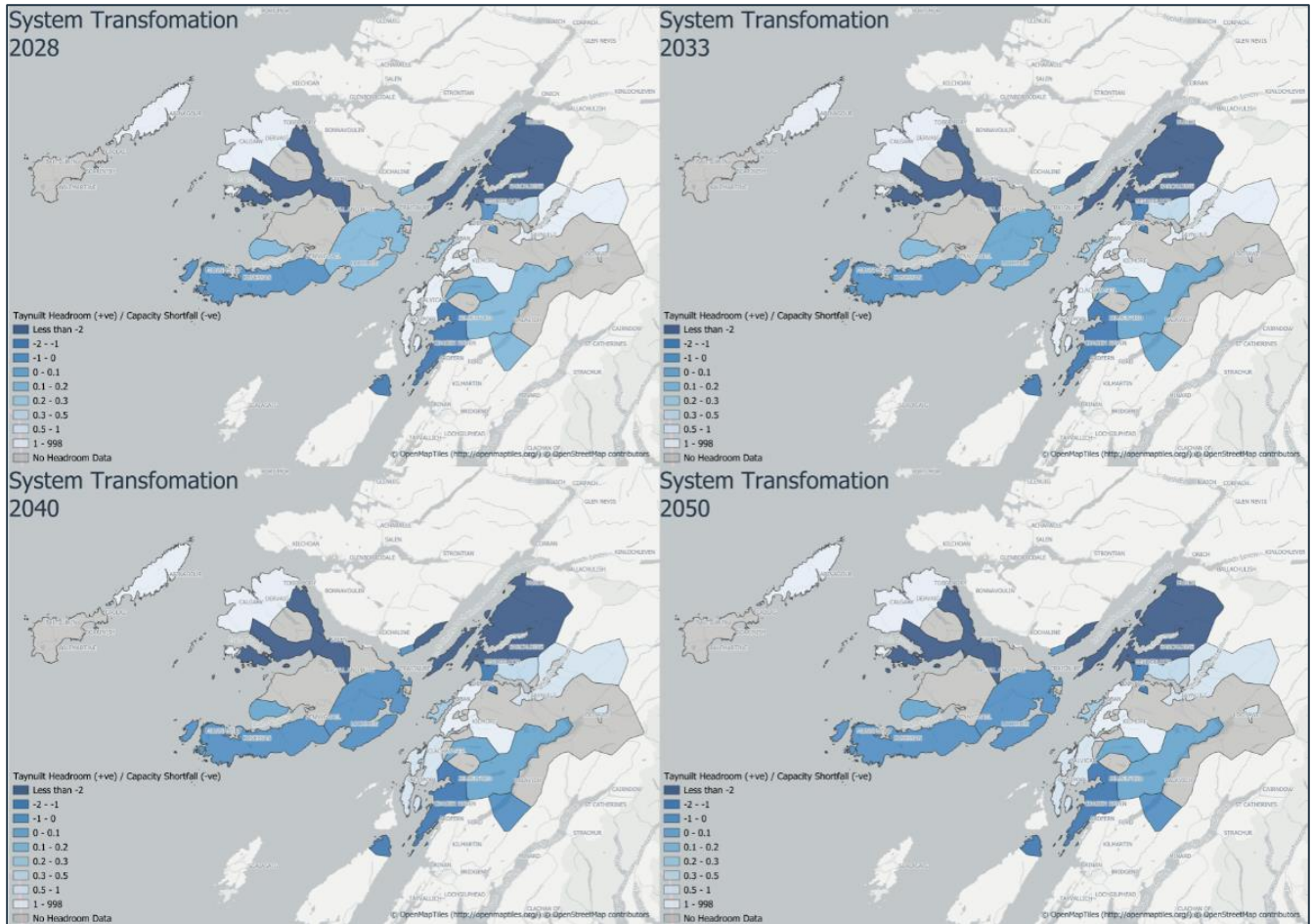


Figure 18 Taynuilt GSP EHV spatial plans for ST 2028, 2033, 2040, and 2050

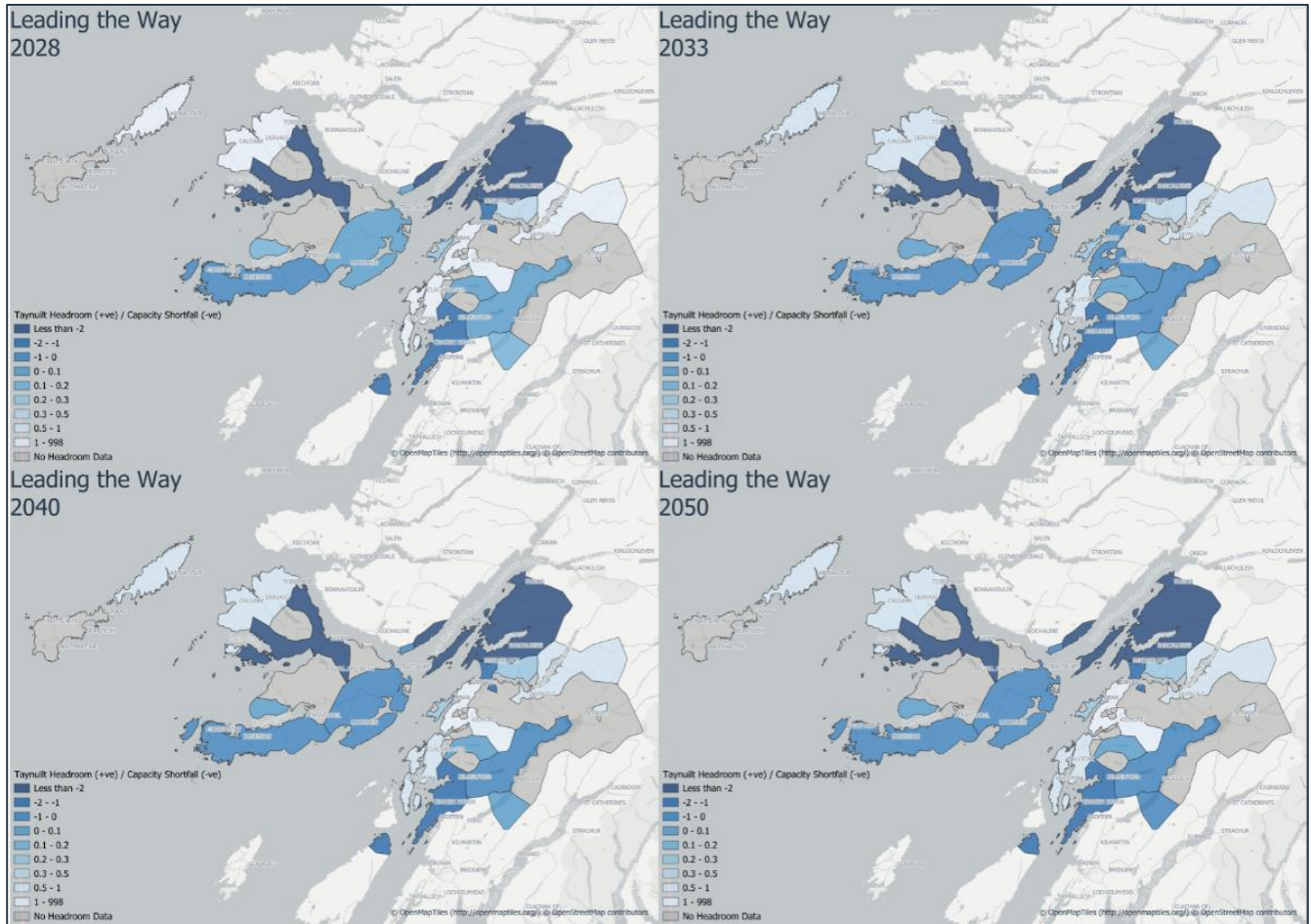


Figure 19 Taynuilt GSP EHV spatial plans for LW 2028, 2033, 2040, and 2050

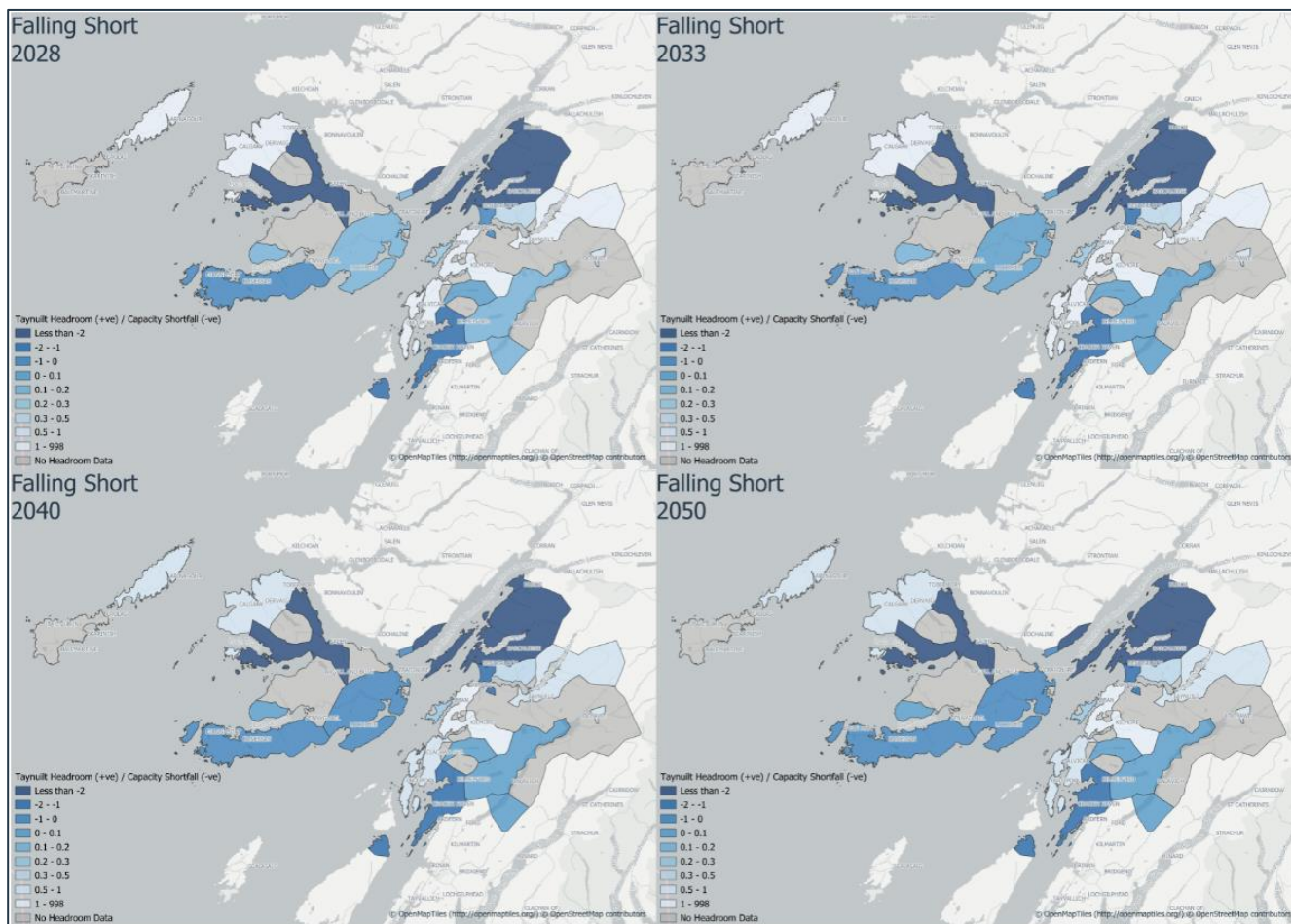


Figure 20 Taynuilt GSP EHV spatial plans for FS 2028, 2033, 2040, and 2050

## 6.2. Extra High Voltage Specific System Generation Needs

There will be an increase level of generation on Taynuilt GSP, with hydropower and onshore wind farm uptake in the region. This volume of generation will likely drive the need for both distribution and transmission reinforcement (carried out by SHET), which would include new 33kV circuits between existing substations or potentially new GSPs to accommodate the level of generation connections. These needs are assessed in detail in Section **Error! Reference source not found.**

## 6.3. Extra High Voltage Specific System Demand Needs

There will be a need to carry out reinforcement works around Taynuilt GSP specifically at primary substation levels where the existing transformers cannot accommodate the projected increase in demand under N-1 conditions. This is primarily around Oban Primary, where the demand increases significantly by 2050. There will also be a need to carry out N-1 and N-2 network resilience reinforcement works on the subsea cables supplying the Islands of Coll and Tiree. This will ensure compliance with P2/8 and our enhanced resilience policy for island groups supplied via subsea cables.



## 6.4. HV/LV spatial plans

To understand, where load is growing at a lower voltage levels, we have used information from the SSEN load model. The secondary transformer projected percentage loadings for each of the four DFES scenarios are highlighted in **Error! Reference source not found.1**, **Error! Reference source not found.2**, **Error! Reference source not found.3** and **Error! Reference source not found.24** for CT, LW, FS and ST respectively. As shown in the legend, the points are coloured based on their percentage loading with green being low percentage loading and darker reds being higher percentage loading (see legend for detail on loading bands and colouring).

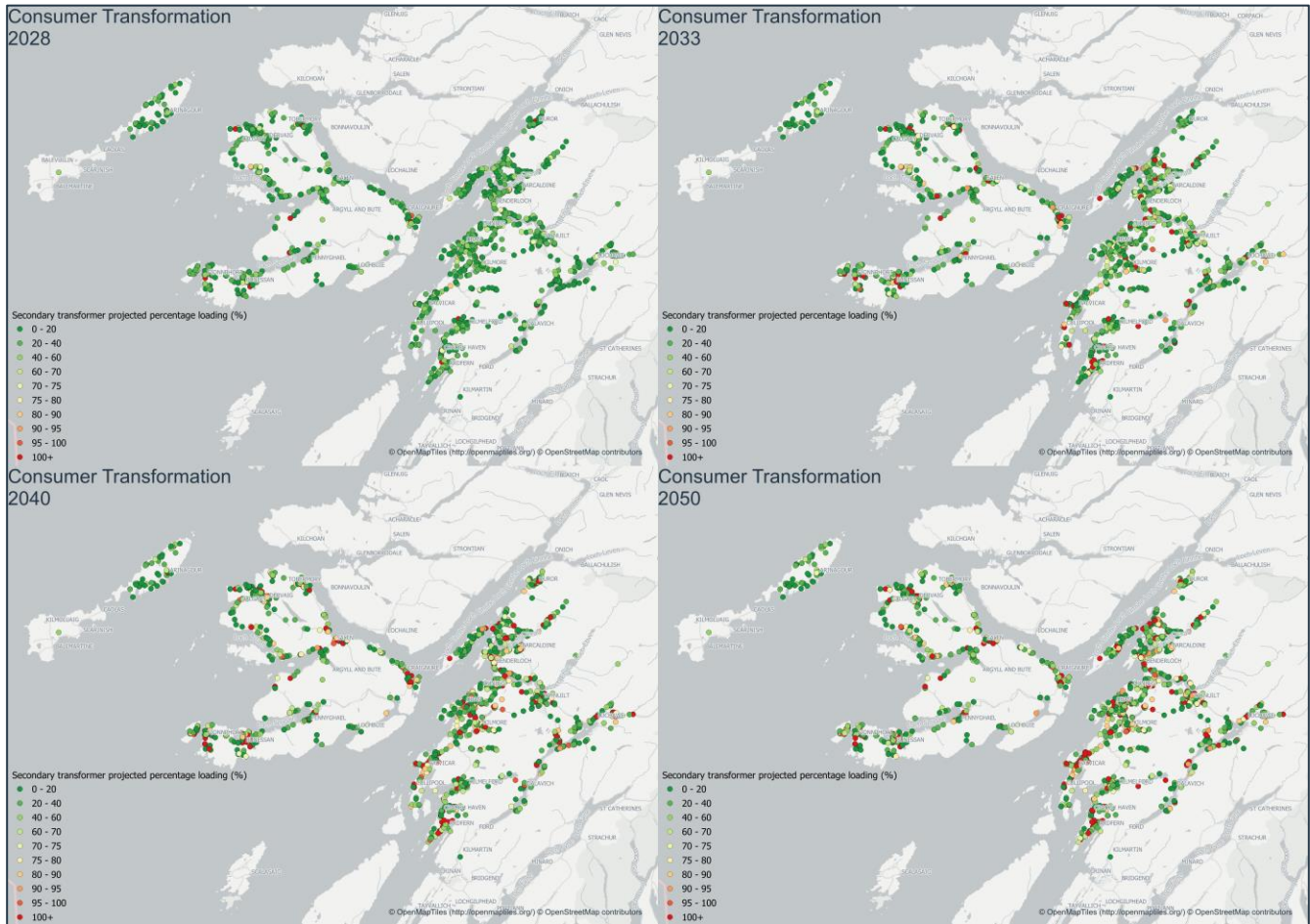


Figure 21 Taynuilt GSP HV/LV network spatial plans for CT 2028, 2033, 2040, and 2050



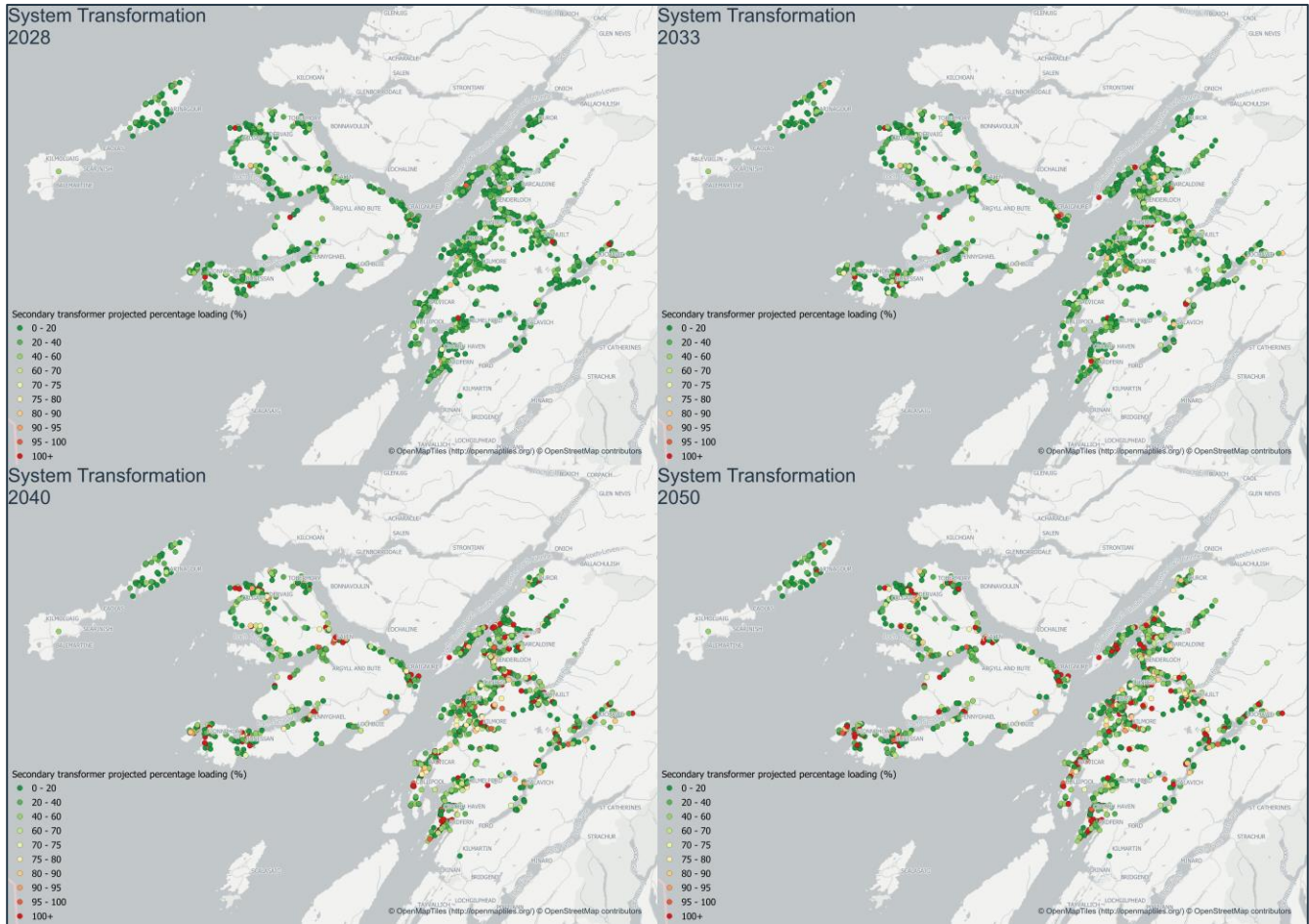


Figure 22 Taynuilt GSP HV/LV network spatial plans for ST 2028, 2033, 2040, and 2050

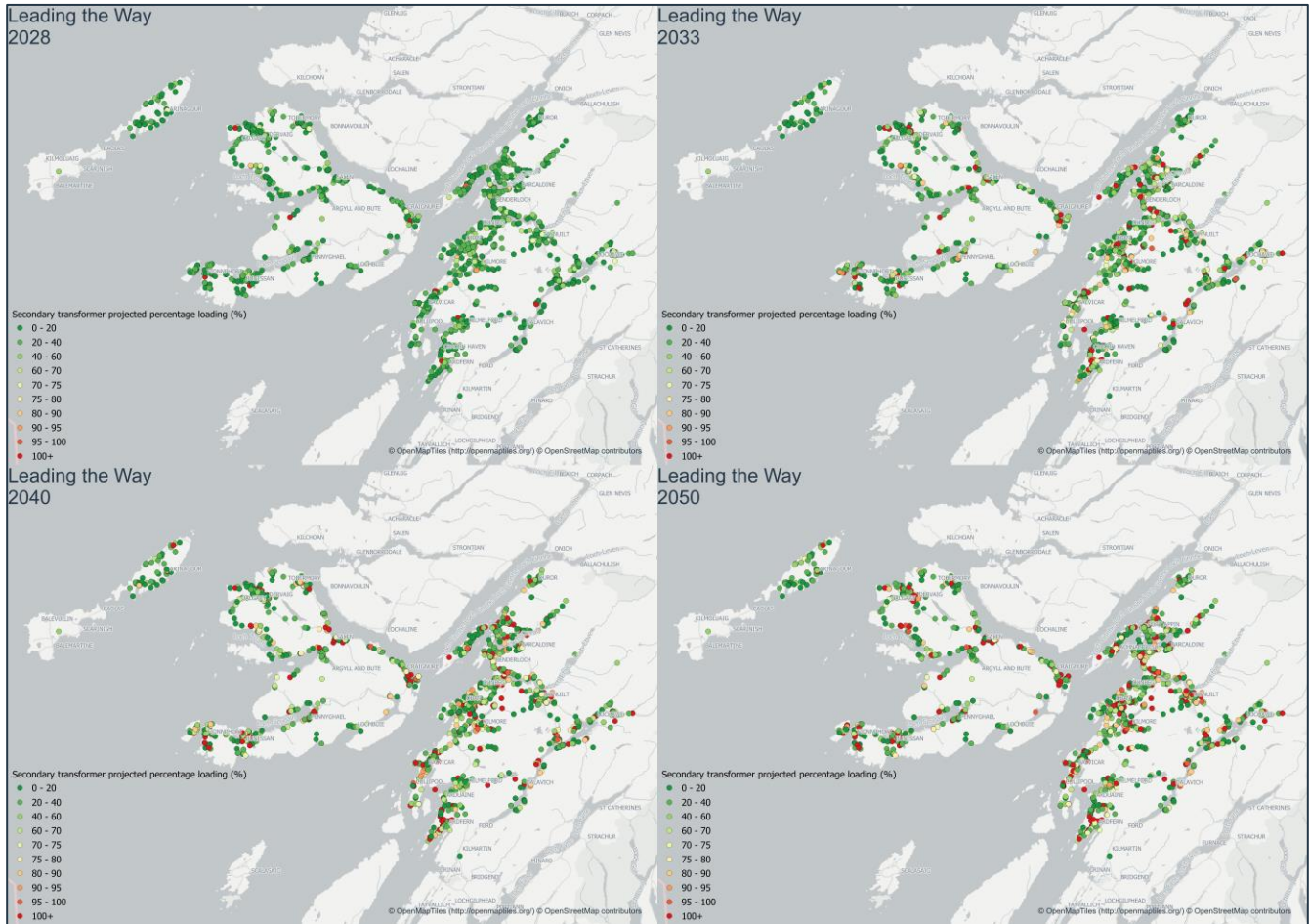


Figure 23 Taynuilt GSP HV/LV network spatial plans for LW 2028, 2033, 2040, and 2050

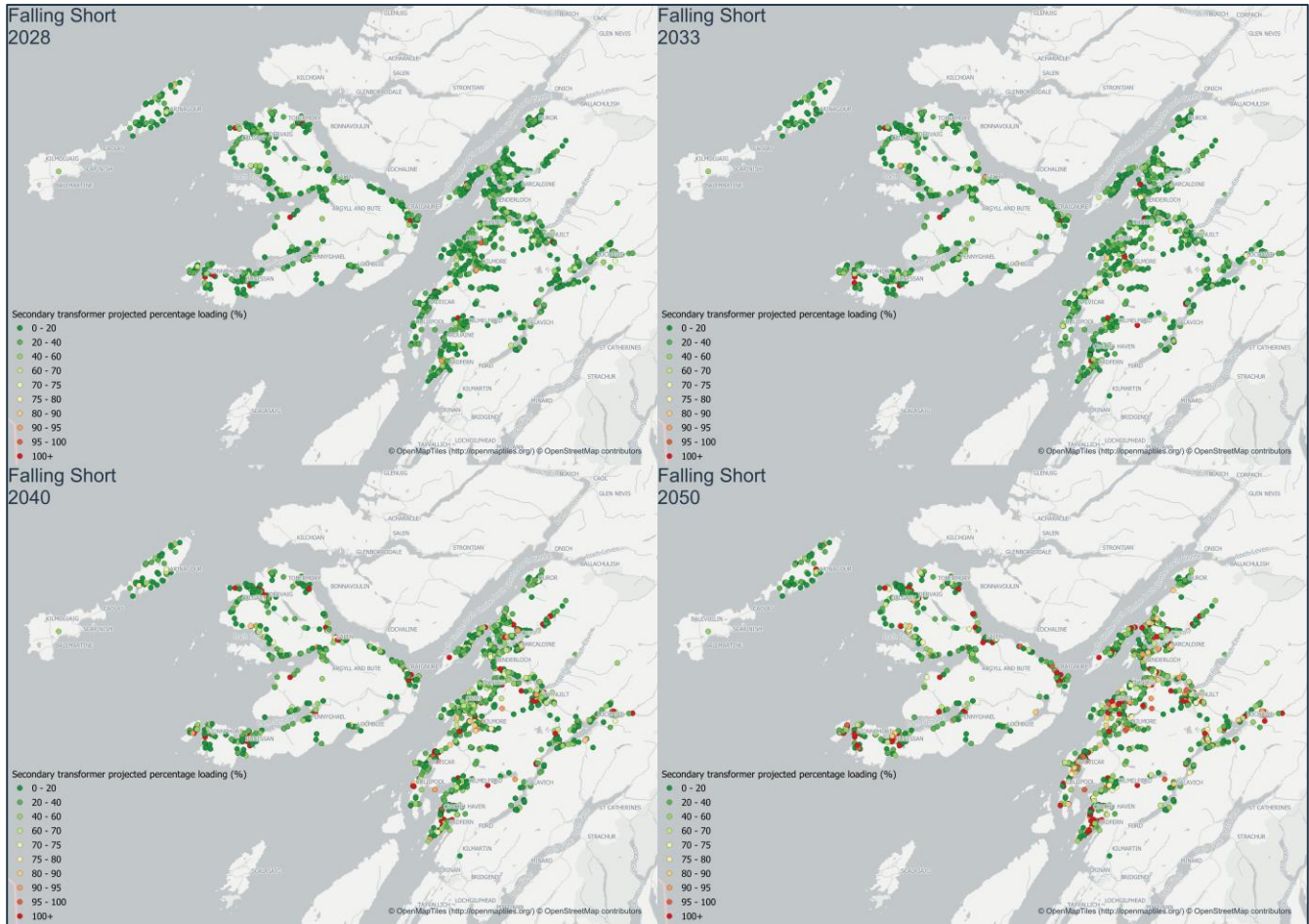


Figure 24 Taynuilt GSP HV/LV network spatial plans for FS 2028, 2033, 2040, and 2050



## 7. OPTIONS TO RESOLVE

The relevant spatial plans provide us with a strategic view of future system needs. We have reviewed this through thermal power system analysis to understand the specific requirements of our EHV networks through to 2050. This analysis has been based on the insights developed from the 2023 DFES alongside other information including known connection applications. Initial needs have been identified using the DFES Consumer Transformation background with sensitivity analysis undertaken against the other three DFES backgrounds.

In this section we propose initial options to resolve these needs. These will be further developed through the HOWSUM and DNOA processes, where they will be considered alongside the potential for flexibility.

The options consider scenarios for both summer and winter to ensure the varying demand and support from local generation combinations were all accounted for. Contingency N-2 considerations for islands supplied by subsea cables have also been undertaken.

The section is split into three parts. There are no additional needs identified beyond 2035 at this time on the EHV network.

- EHV options to 2035 affecting relevant Hebridean islands – these are required for the connections to the relevant Inner Hebridean islands and therefore will fall within the scope of the HOWSUM project to develop further.
- EHV options to 2035 affecting the mainland – these are proposed works are focused at Oban primary substation and Tullich switching station.
- Future HV/LV system needs to 2050 – the future needs of the HV and LV networks are locationally specific but can be considered as an aggregated volume. In this section we provide information on our future forecasts for local HV and LV network needs.

### 7.1. Overall dependencies, risks, and mitigations

There are several overarching risks to the delivery of our strategic plan. Below we list these alongside proposed mitigating actions. We will work with stakeholders to develop these mitigating actions further.

#### Network Output Delivery

**Dependency:** Works proposed here are dependent on the supply chain required to deliver the project. It has been tested through delivery of RIIO-ED1 projects. This has shown that the supply chain is able to provide the capacity and skills required to deliver these projects. As we move into RIIO-ED2 with the increased amount of CAPEX delivery required it is important for us to ensure that the supply chain can continue to deliver.

**Risks:** Works delay potential interventions downstream and/or cannot deliver the subsea cable on time.

**Mitigation:** In response to this we have commenced early market engagement with subsea cable installation contractors to ensure that the capacity and skills to deliver this project are available.

#### Flexibility Services

**Dependency:** Procurement of flexible services to defer reinforcement where possible and economically viable.



**Risks:** Insufficient flexibility in the relevant area to resolve system need.

**Mitigation:** Flexibility service procurement carried out ahead of time with signposting of future needs. Last build date identified to allow time for traditional reinforcement if flexibility not viable.

## 7.2. 2050 High Level Options for EHV network

This section provides more detail on the high-level options to resolve system needs in the period through to 2050. These have been identified through thermal power system analysis and the impact on all four DFES scenarios has been considered.

### 7.2.1. EHV Options to 2035 affecting relevant Inner Hebridean islands

This section summarises the high-level options required to 2035 affecting Inner Hebridean islands.

The options listed in this section outline potential approaches to address individual constraints on the network. A combination of these options will be required to meet system needs out to 2050. Going forward, detailed analysis of these proposed options will be required to ensure that there is a comprehensive and cost-effective solution, which aligns with a whole-system approach to ensure maximum value for our customers whilst meeting the demand and generation needs of the network. This will be progressed through the HOWSUM process.

The Islands of Coll/ Tiree are currently supplied via a single 11kV subsea cable from Dervaig Primary on Mull. The islands are supported in fault scenarios by a 2.8MW diesel embedded generation station on Tiree. Analysis of the consumer transformation DFES scenario indicates that the combined demand of Coll and Tiree will exceed the 4MW threshold for N-2 levels of resilience by 2029. To achieve this level of resilience the following options could be implemented.

Option	Description	Benefits	System Need Driver	Schematic Reference
Augmentation of 11kV subsea	Additional 11kV CCT Dervaig Primary – Coll, Additional 11kV CCT Coll - Tiree	Allows installation on an existing known route.	Resilience	1
New 33kV subsea	New 33kV subsea on existing 11kV route. Establish New Primary on Coll. Augment 11kV subsea Coll - Tiree	Allows installation on an existing known route with a higher rated capacity.	Resilience	2
New 11kV subsea	Establish new 11kV subsea route from New Bunessan Primary to Tiree Power Station.	Greater network flexibility and resilience against a single point of failure	Resilience	3



New 33kV subsea	Establish new 33kV subsea route from New Buessan Primary to Tiree Power Station. Establish new Primary Substation at Tiree Power Station	Greater network flexibility and resilience against a single point of failure with a higher rated capacity	Resilience	4
New 11kV subsea	Establish new 11kV subsea route from Salen Primary to Tiree Power Station	Shorter subsea cable required with greater network resilience against a single point of failure	Resilience	5

**Table 6 Options for system needs 2029-2035**



**Figure 25 Network schematic with system needs 2041-2050 Option 1 – Augmentation of 11kV subsea.**



Figure 26 Network schematic with system needs 2041-2050 Option 2 – 33kV on Existing Route.

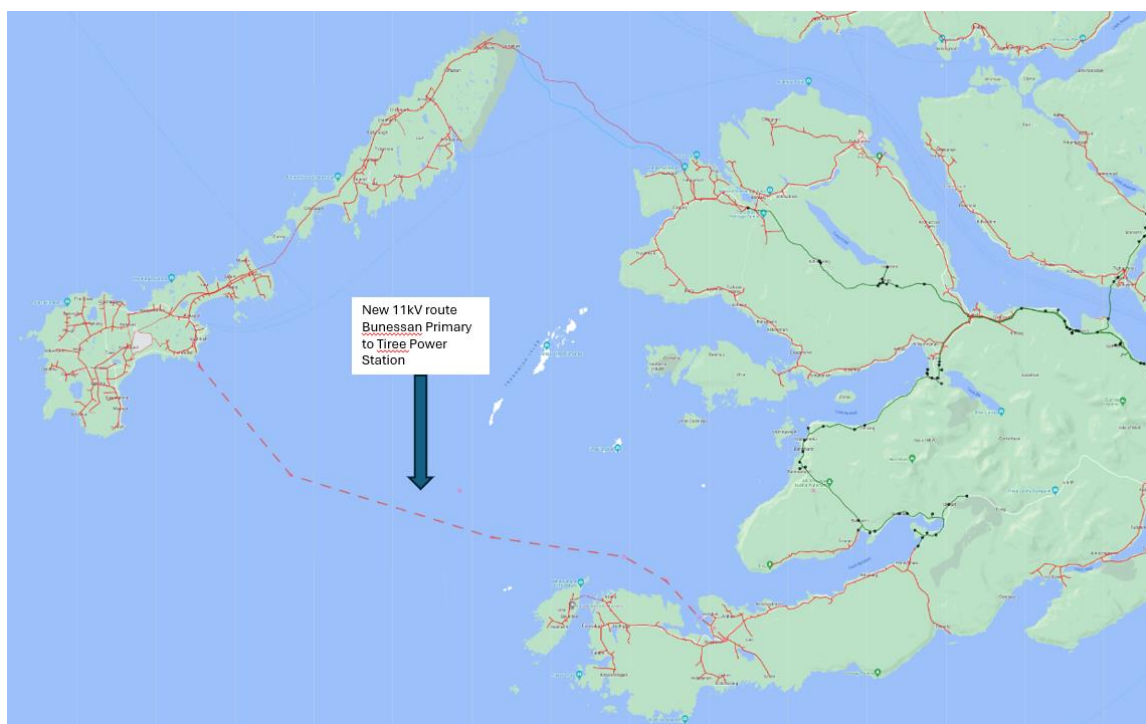


Figure 27 Network schematic with system needs 2041-2050 Option 3 – 11kV subsea from New Bunesan Primary.

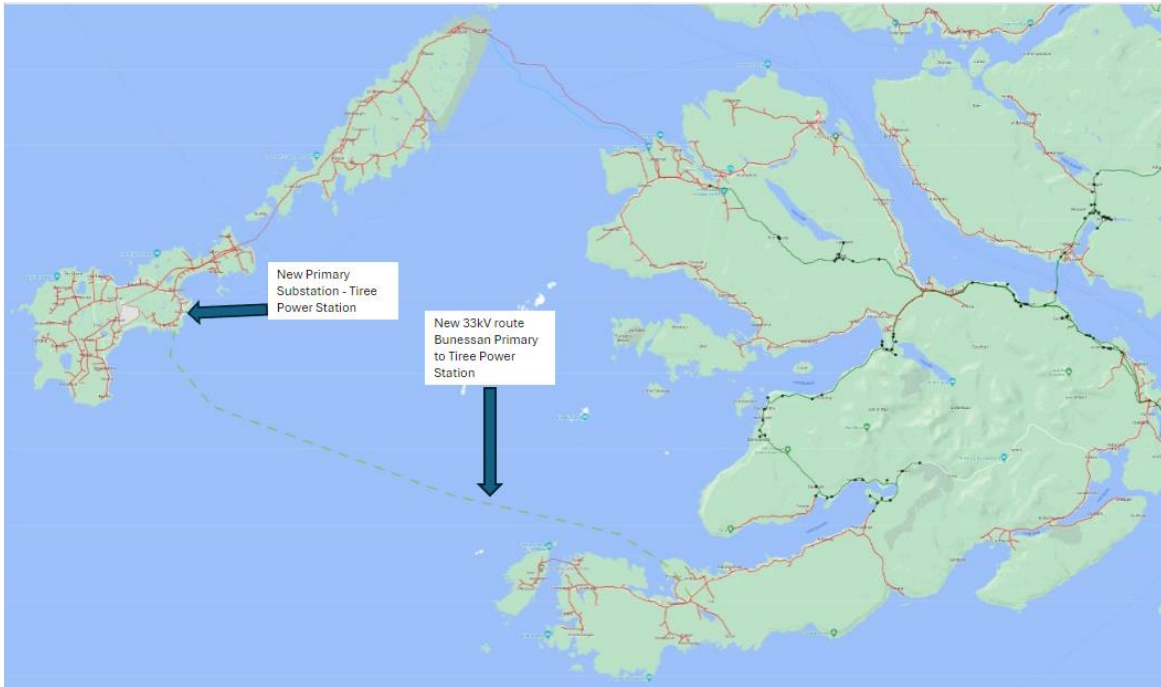


Figure 28 Network schematic with system needs 2041-2050 Option 4 – 33kV subsea New Bunessan Primary.



Figure 29 Network schematic with system needs 2041-2050 Option 5 – 11kV subsea from Salen Primary (Calgary).

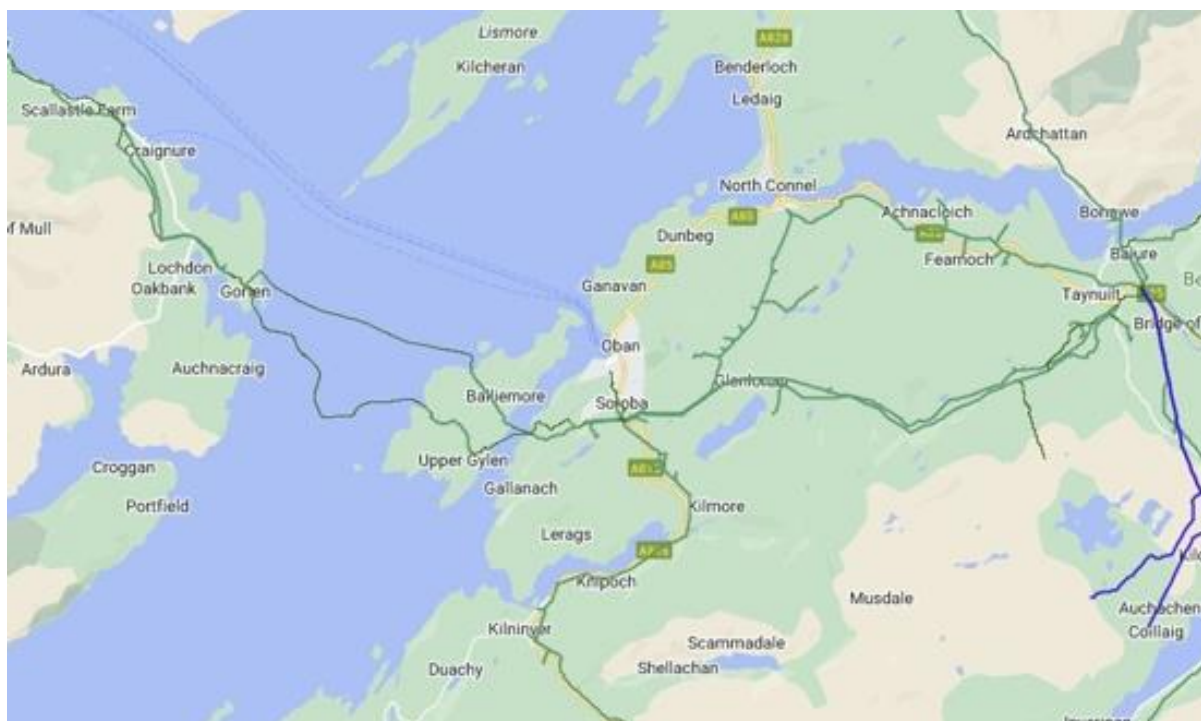
The Isle of Mull is currently supplied via two 33kV subsea cables via Tullich Switching Station on the outskirts of Oban. Analysis of the consumer transformation DFES scenario indicates that the demand of Mull, Coll and Tiree will exceed the 4MW threshold for N-2 levels of resilience by 2023. To achieve this level of resilience the following options could be implemented.





Option	Description	Benefits	System Need Driver
Additional 33kV Infeed plus demand management	Establish a new 33kV line from Tullich SW/STN to Lochdonhead	Cost Effective	Resilience
Additional 33kV Infeed plus demand management plus voltage compensation	Establish a new 33kV line from Tullich SW/STN to Lochdonhead plus additional voltage compensation at Rulich SW/STN	Addresses voltage issues and allows for future demand/ generation growth	Resilience

**Table 7 Options for system needs at Tullich switching station 2029-2035**



**Figure 3030 Network schematic with system needs 2029-2035 – Tullich to Mull 33kV**



## 7.2.2. EHV Options to 2035 affecting the mainland network

Additional system needs have been identified on the mainland that the DFES 2023 signposts may need addressing ahead of 2035. These have been identified through thermal power system analysis completed on the consumer transformation scenario. These are comprised of works at Tullich Switching Station and Oban primary substation.

### 7.2.2.1. Tullich Switching Station

Beyond the ED2 the power system study assessment identified that the undervoltage issues affect the areas addressed above including the Tullich switching station. Without the reactive power support, the voltages are further reduced compared to the ED2 period. This is in part driven by a significant load increase predicted at the Oban primary substation. Studies indicated that significant reactive power support would be required around the Tullich station to resolve the issue, which makes such solution not feasible. Possible solutions are as follows.

Option	Description	Benefits	System Need Driver
Additional 33kV Infeed	Establish a new 33kV line from Taynuilt GSP to Tullich SW/STN	Cost Effective	Demand
Upgrading Tullich SW/STN to 132kV	Bringing the nearby 132kV line from Taynuilt to Tullich and converting the Tullich switching station to a GSP 132/33kV substation	Addresses voltage issues and allows for future demand/ generation growth	Demand

**Table 4 Summary of potential Options (Tullich Undervoltage)**

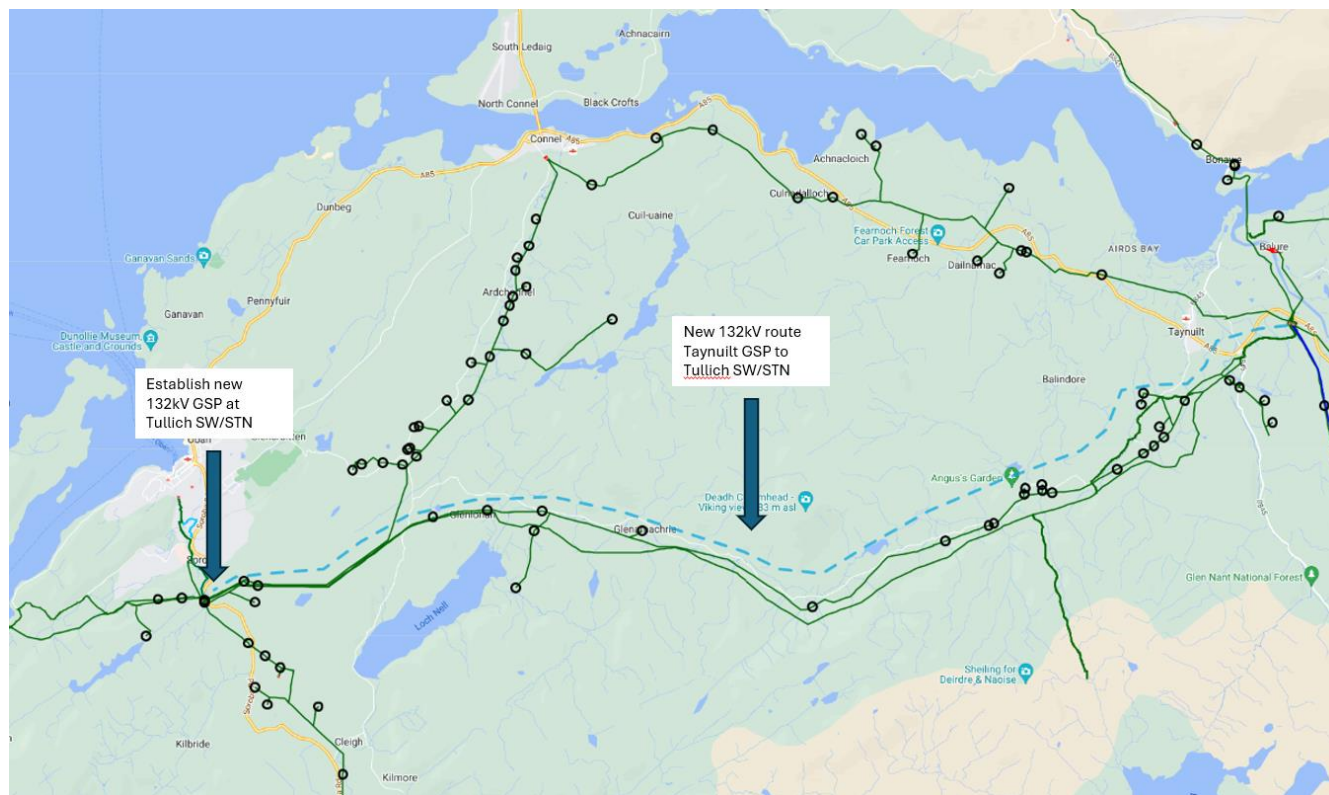


Figure 31 Network schematic with system needs 2029-2035 – Upgrading Tullich SW/STN to 132kV

### 7.2.2.2. Oban Primary

To address the issue of the significant load increase at Oban in the period 2028-2035 the following high-level solution is proposed for further consideration.

Option	Description	Benefits	System Need Driver
Additional Primary Substation	Establish a new substation between Oban and Connel where high Oban load growth is expected	Allows splitting of load between new and existing primaries. Potentially easier delivery on virgin site	Demand
Upgrading existing primary transformers	Upgrade the existing 24MVA transformers to 40MVA units	Cost effective. Site already established.	Demand

Table 5 Summary of potential Options (Oban Primary)

## 7.3. Future requirements of the High Voltage and Low Voltage Networks



Our HV/LV spatial plans indicate that there is no clear pattern to future demands on these lower voltage networks. We are therefore planning on a forecast volume basis and this section provides further context on this work for both the Taynuilt high voltage and low voltage network needs to 2050.

### 7.3.1. High Voltage Networks

As well as the EHV system needs identified in the previous section, increased penetration of low carbon technologies (LCTs) connecting to the distribution network will result in system needs on the High Voltage (HV) and Low Voltage (LV) networks. To provide a view on the impact of these technologies on the distribution network here we have used the load model that is produced by SSEN's Data and Analytics team.<sup>9</sup>

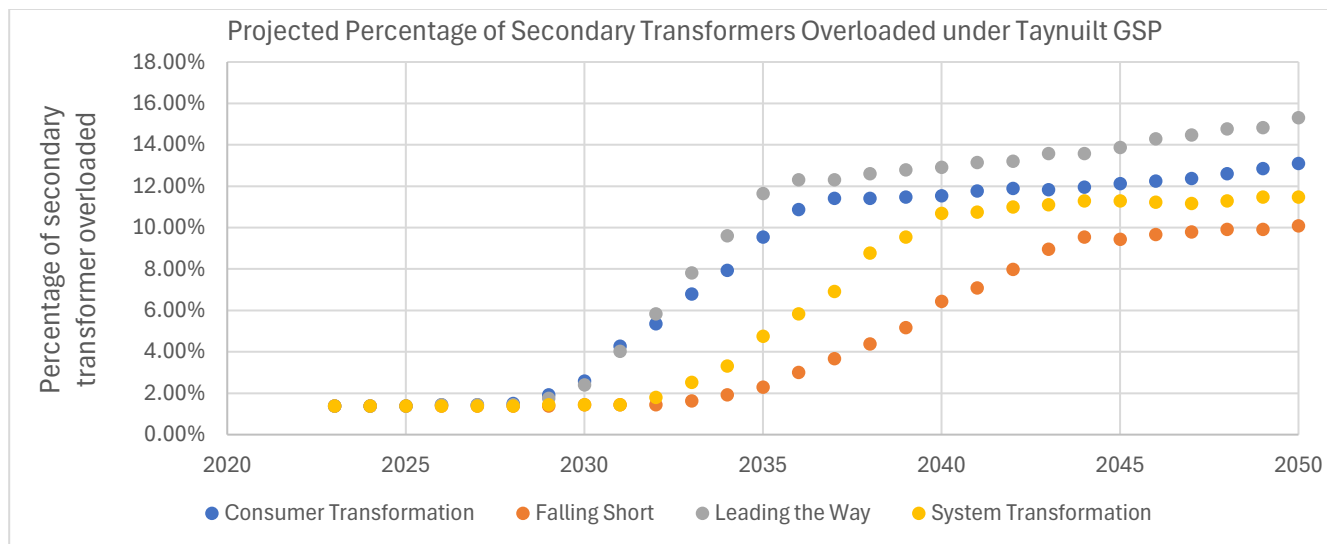
The load model is a machine learning product which estimates a half-hourly annual demand profile for each household based on a series of demographic, geographic and heating type factors. This enables us to estimate capacity on the electricity network while protecting individual customers data privacy by using modelled data. These views are then aggregated up the network hierarchy based on the combinations of customers associated with each asset. This view is supplemented with the DFES to highlight the projected impact of LCTs on the network.

For the 20 primary substations supplied by Taynuilt GSP, the percentage of secondary substations where projected peak loading exceeds the nameplate rating of the secondary transformer was taken from the load model data. **Figure 17** demonstrates how this percentage changes under each DFES scenario from now to 2050.

To satisfy these requirements a variety of solutions will need to be investigated. It is likely that a combination of flexibility and asset replacement will be employed to resolve the projected HV system needs. It is important to note that for HV needs, flexibility is likely to be provided through Distributed Energy Resources (DER), Consumer Energy Resources (CER), and domestic/commercial Demand Side Response (DSR). One of the challenges associated with procuring flexibility to High Voltage and Low Voltage system needs is that only a small number of customers can provide a flexible service due to the requirement to be supplied by a specific secondary transformer. As the role of aggregators develops, we may see a shift in the potential for flexibility in an area. Where the magnitude of an overload is too large for flexibility to be feasible, addition of new assets or asset replacement will be necessary.

---

<sup>9</sup> SSEN Open Data Portal, 2023, SSEN Secondary Transformer – Asset Capacity and Low Carbon Technology Growth.  
Taynuilt GSP Strategic Development Plan



**Figure 32 Taynuilt Projected Secondary Transformer Loading. Source: SSEN Load Model**

### 7.3.2. Low Voltage Networks

Drivers for interventions in low voltage networks may be either capacity related or be driven by voltage requirements. We are progressing options to resolve both drivers. From a network perspective the solution typically involves upgrading the number of LV feeders to split/ balance the load and improve voltage or to install another substation at the remote end of the LV network to balance load and improve voltage. In both instances, flexibility at a local level, especially voltage management products linked to battery export and embedded generation such as solar is likely to be required alongside traditional reinforcement.

We are leveraging recent innovation work through Project LEO (Local Energy Oxfordshire) and My Electric Avenue to inform this strategy. Enhanced network visibility through Smart meter data analytics and low-cost substation feeder monitoring is also necessary to enable appropriate dispatch of services and network reconfiguration.

Capacity driven needs – Thermal constraints tend to materialise in the sections of cable leading to the substation (transformer) where multiple customer loads sum together. We are modelling requirements out to 2050 leveraging low voltage monitoring and metering equipment combined with analytical techniques. This will demonstrate how the magnitude of the system need of the LV network changes for remote rural communities including those on Scottish Islands across scenarios and years out to 2050.

Voltage driven needs – Generally, connection of Low Carbon Technology and large loads such as heat pumps is limited by voltage constraints before thermal constraints when located more than around 150m from the local secondary transformer. Increased loading on our low voltage networks can reduce the voltages to consumer premises. This is a non-linear relationship and as such requires more complex analysis. We are currently undertaking analysis to better understand the extent of this future need.

Initial analysis indicates that 3.2% of low voltage feeders may need intervention by 2035 and around 4% by 2050 under the CT scenario as shown in Figure 41. This is based on data from remote rural areas across the North of Scotland. The need is unlikely to be triggered until 2028 onwards. However, due to the timeline to grow workforce, with jointing skills taking typically 4 years to be fully competent, it is necessary to start recruitment and initiate programmes ahead of need to be able to deliver the required volumes from 2028 onwards.

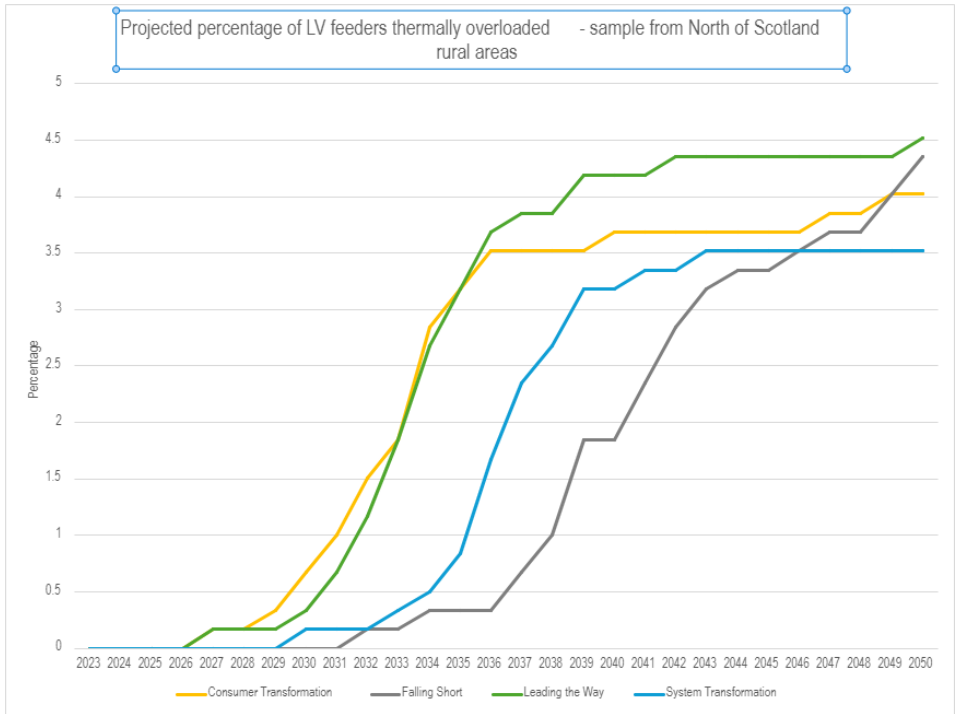


Figure 31 Percentage of LV feeders projected to be overloaded in Northern Scotland remote rural areas



## 8. RECOMMENDATIONS

The review of stakeholder engagement and the SSEN 2023 DFES analysis provides a robust evidence base for future needs across Taynuilt GSP group in both the near and longer term. Drivers for change across Taynuilt GSP arise from multiple sectors and technologies. These drivers impact not only our EHV network but will drive system needs across all voltage levels. They are driven by both demand and generation needs, as well as system resilience and detailed optioneering will need to consider a range of credible scenarios.

Across Taynuilt GSP group, a variety of works have already been triggered through the DNOA process and will be published in upcoming DNOA Outcomes Reports. These are driven by customer connections and system needs that will arise this decade but are being developed to meet 2050 needs.

The findings from this report have provided evidence for 5 key recommendations:

1. Proposed works to resolve the mainland system needs in the period through to 2035 should be assessed through the DNOA methodology.<sup>10</sup> This will allow for a variety of solutions to be considered and the effect of flexible solutions to be assessed including flexibility in Load Managed Areas. The DNOA process will then provide insight on the solution to the system need that provides the most benefit to customers.
2. The EHV high level plans affecting the Inner Hebridean islands should be developed and refined further through the HOWSUM process. This can allow for a robust case for works to be undertaken in the near future to improve the infrastructure to Coll and Tiree;
3. The connection of low carbon technologies across the HV and LV networks will result in significant demand growth. Where it has been identified that there are overloads projected, mitigations will need to be put in place. There is no clear pattern to low voltage load growth in Taynuilt GSP so we are taking a volume driver approach. This needs to be based on strategic modelling of LV networks to understand the volume of work needed.
4. SSEN should continue to proactively engage with key stakeholders to scope longer term works that have been signposted in this document. This could take the form of input from Local Area Energy Plans (LAEPs), or more specific engagement on the details of individual projects. This needs to include discussions on related activities such as land availability and usage.
5. SSEN should continue to actively engage with specific large customers in Taynuilt GSP with the aim of refining its demand forecast methodology for industries such as distillery and ports which will play a major role in driving network reinforcements.

Actioning these recommendations will allow SSEN to develop a network that supports local net zero ambitions. By doing so, contributing to net zero targets at a national level.



# APPENDIX A – GLOSSARY

ACRONYM	DEFINITION
ANM	Active Network Management
BAU	Business as Usual
CER	Consumer Energy Resources
CMZ	Constraint Managed Zone
CT	Consumer Transformation
DEG	Diesel Embedded Generation
DER	Distributed Energy Resources
DFES	Distribution Future Energy Scenarios
DGAD	Distributed Generation Automatic Disconnection
DNO	Distribution Network Operator
DNOA	Distribution Network Options Assessment
DSR	Demand Side Response
EHV	Extra High Voltage
EJP	Engineering Justification Paper
ER P2	Engineering Recommendation P2
ESO	National Grid Energy System Operator
EV	Electric Vehicle
FES	Future Energy Scenarios
FS	Falling Short
GSPs	Grid Supply Points
HV/LV	High Voltage/Low Voltage
HOWSUM	Hebrides and Orkney Whole System Uncertainty Mechanism
HVO	Hydrotreated Vegetable Oil
LAEP	Local Area Energy Planning
LENZA	Local Energy Net Zero Accelerator
LW	Leading the Way
OHL	Overhead Line
PV	Photovoltaic





MW	Megawatt
MVA	Mega Volt Ampere
NRS	National Records of Scotland
RIIO-ED1/2	RIIO Electricity Distribution Price Control periods 1 and 2
SBTs	Science Based Targets
SDP	Strategic Development Plan
SHEPD	Scottish Hydro Electric Power Distribution
SLC	Standard Licence Condition
SSEN	Scottish and Southern Electricity Network
ST	System Transformation
SWA	Scottish Whisky Association
WSC	Worst Served Customers



# APPENDIX B – GENERATION CAPACITY FORECASTS

This annex shows aggregated forecast generation capacity of distribution connected projects within Taynuilt GSP.

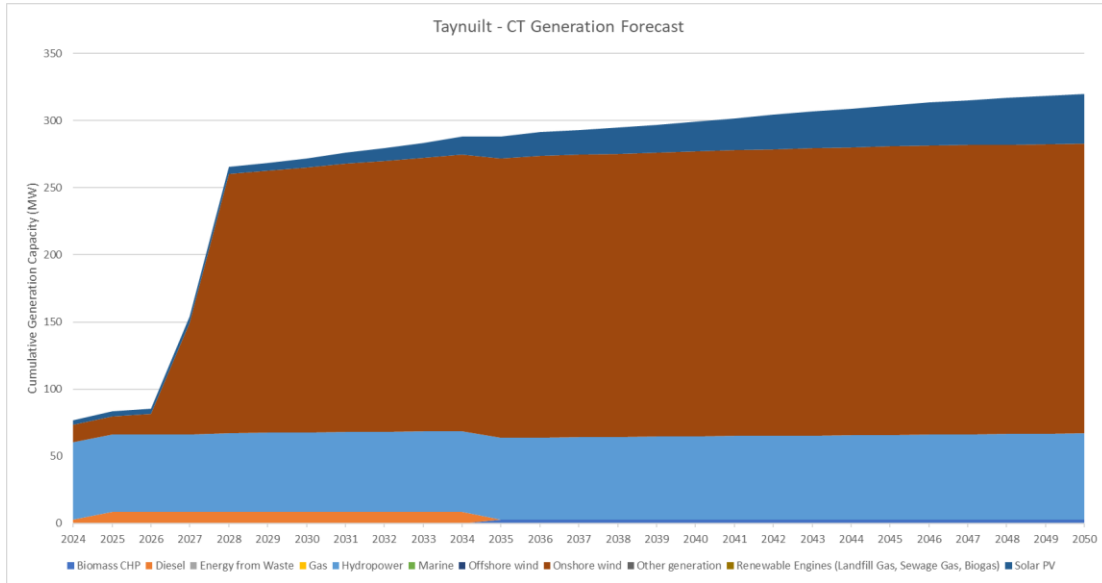


Figure 33 Cumulative Generation Forecast Breakdown by Technology for Taynuilt – CT Source: SSEN DFES 2023

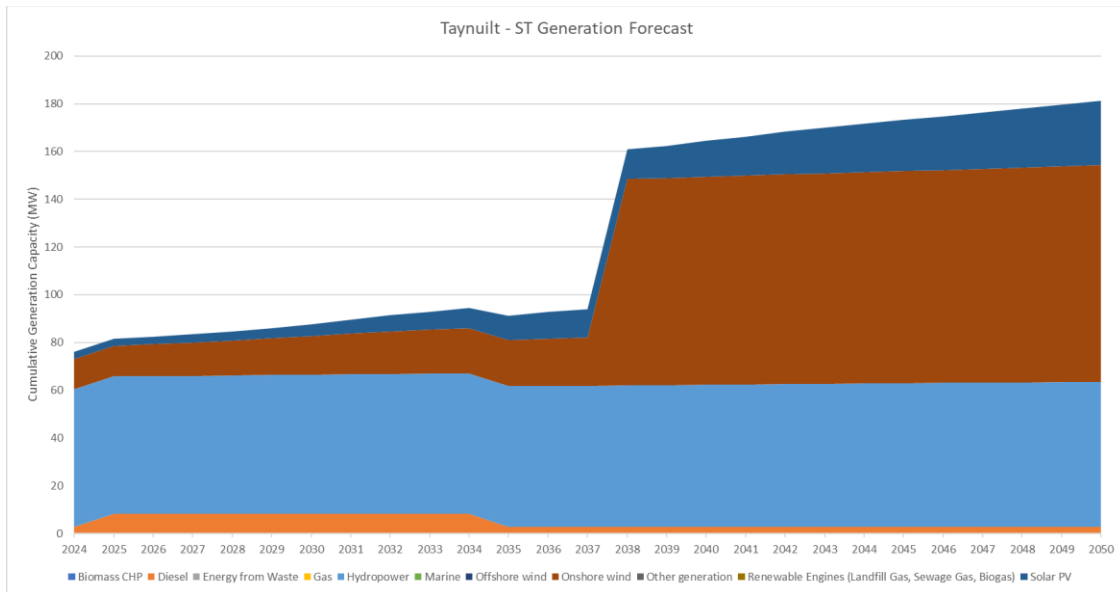
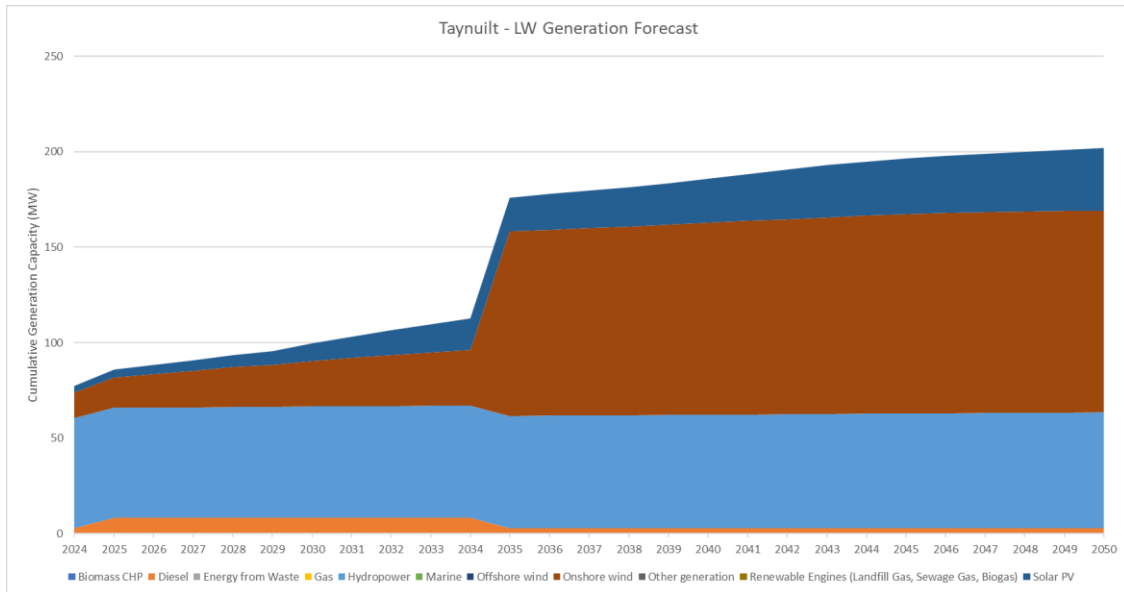
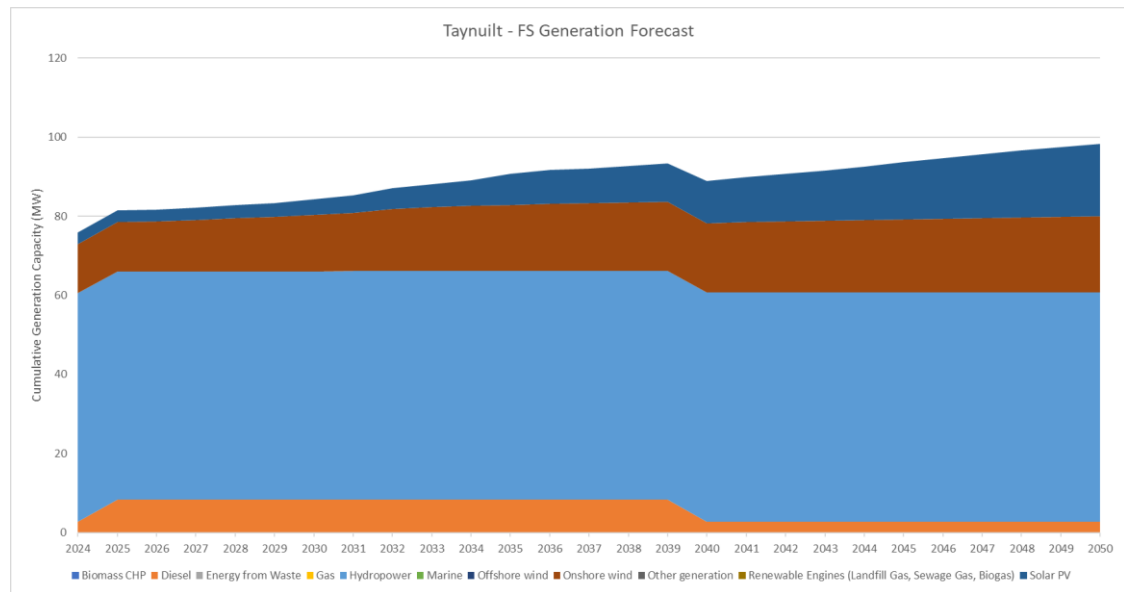


Figure 34 Cumulative Generation Forecast Breakdown by Technology for Taynuilt – ST Source: SSEN DFES 2023



**Figure 35 Cumulative Generation Forecast Breakdown by Technology for Taynuilt – LW Source: SSEN DFES 2023**

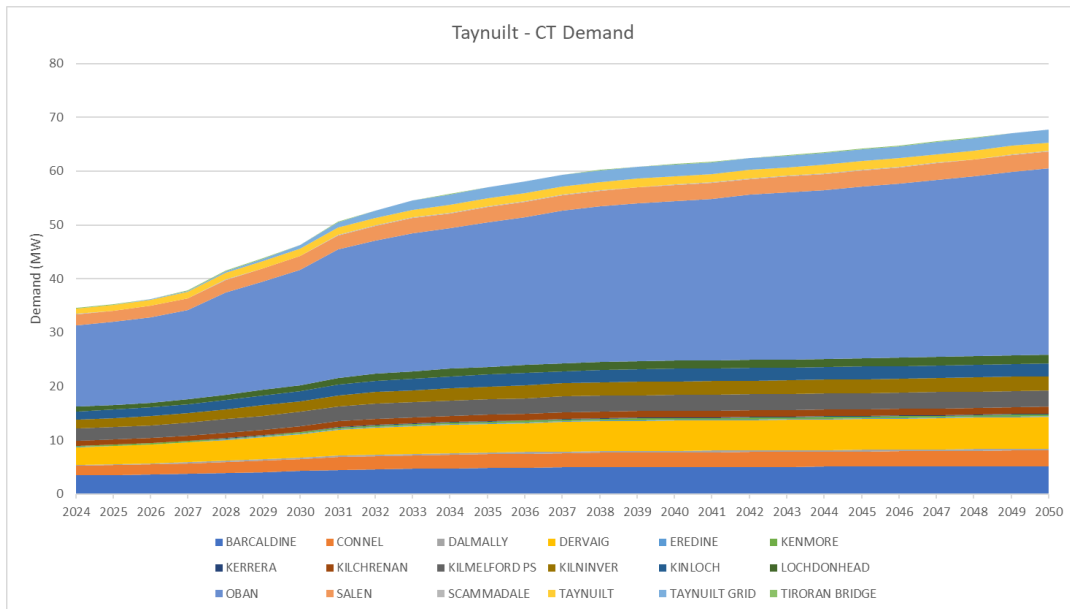


**Figure 36 Cumulative Generation Forecast Breakdown by Technology for Taynuilt – FS Source: SSEN DFES 2023**

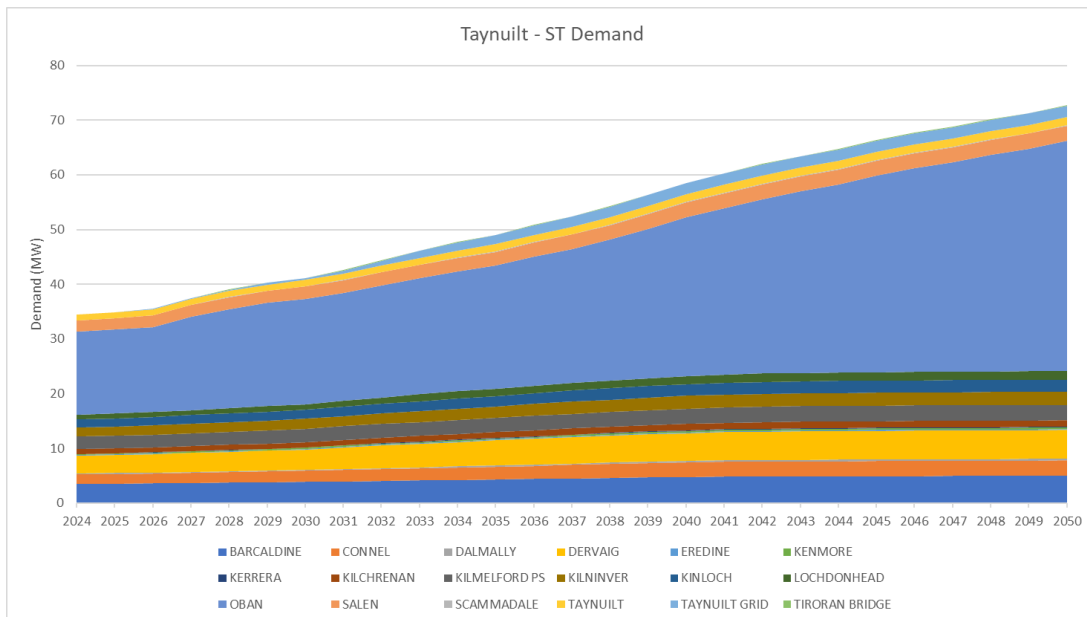


# APPENDIX C – DEMAND FORECASTS

This annex shows the winter peak forecast demand for primary substations within Taynuilt GSP. This data is forecast demand net of embedded generation output.

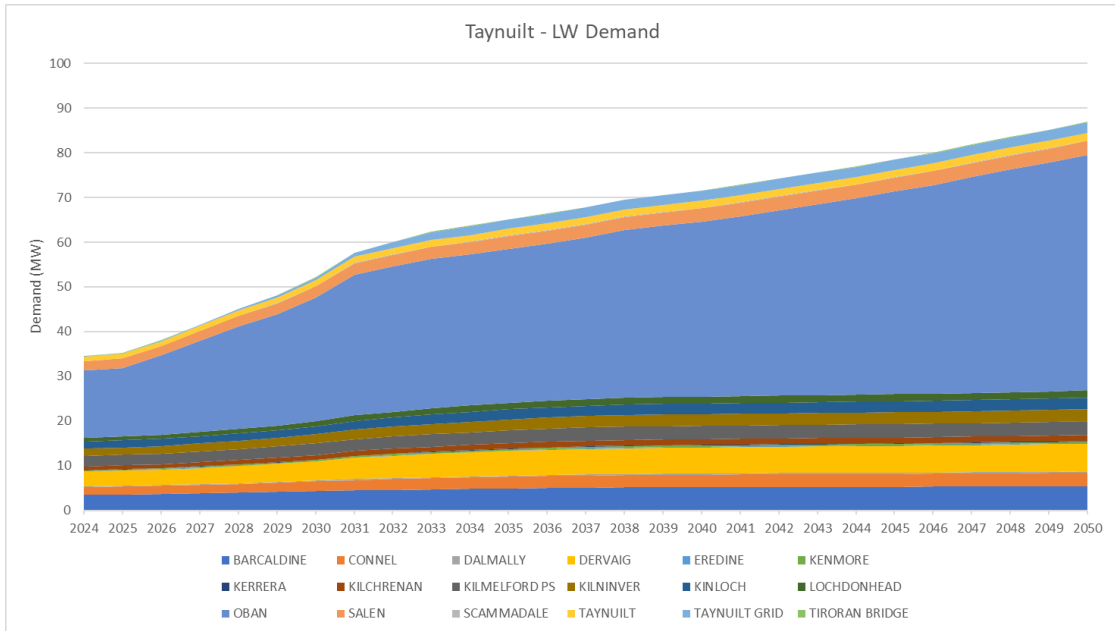


**Figure 37 Demand Forecast for Taynuilt – Breakdown by Primaries - CT Source: SSEN DFES 2023**

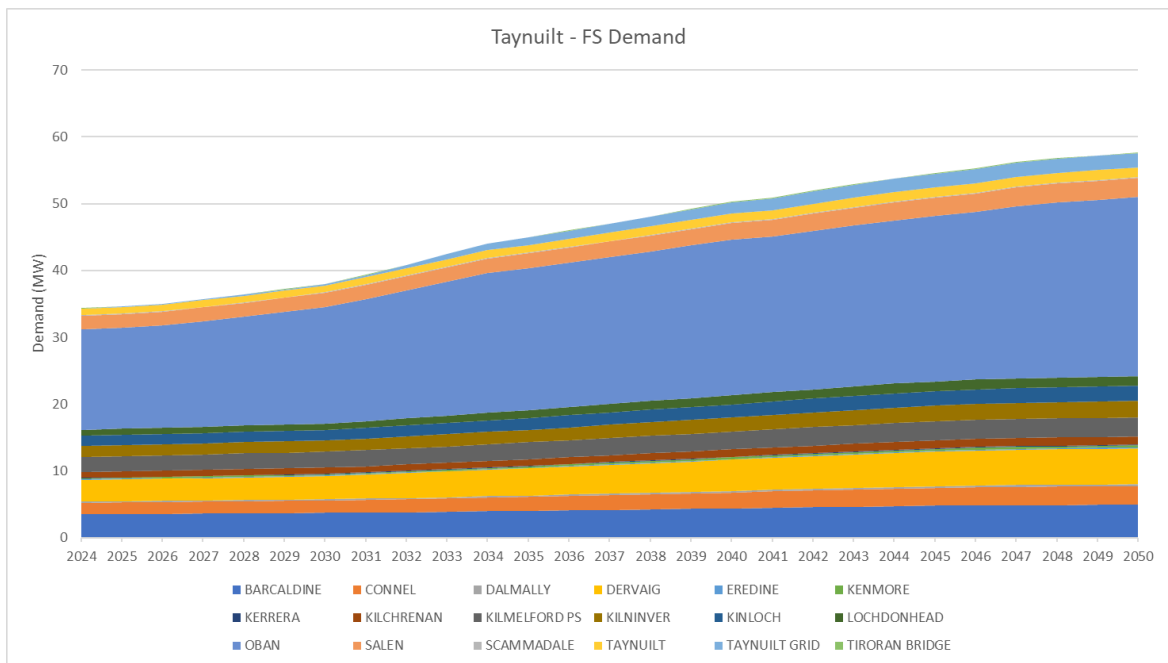




**Figure 38 Demand Forecast for Taynuilt– Breakdown by Primaries - ST Source: SSEN DFES 2023**



**Figure 39 Demand Forecast for Taynuilt – Breakdown by Primaries - LW Source: SSEN DFES 2023**



**Figure 40 Demand Forecast for Taynuilt – Breakdown by Primaries - FS Source: SSEN DFES 2023**



Scottish & Southern  
Electricity Networks



# CONTACT

[whole.system.distribution@sse.com](mailto:whole.system.distribution@sse.com)